

**Feasibility of Membrane Based Treatment Technologies for Brackish Water
Desalination and Effluent Reclamation in the Jordan Valley**

**By
Jalal Bsharat
(1115419)**

**Supervisor
Dr. Eng. Rashed Al-Sa'ed**

Birzeit University, 2013/2014

جدوى تقنيات المعالجة القائمة على الأغشية لتحلية المياه المالحة واستصلاح السيب المعالج
في وادي الأردن

جلال بشارات
(1115419)

المشرف
د. راشد الساعد

Feasibility of Membrane Based Treatment Technologies for Brackish Water Desalination and Effluent Reclamation in the Jordan Valley

By
Jalal Bsharat
(1115419)

This thesis was prepared under the supervision of Dr. Eng. Rashed Al-Sa'ed and has been approved by all members of the Examination Committee.

Dr. Eng. Rashed Al-Sa'ed
(Chairman of the Committee)

Dr. Nidal Mahmoud
(Member)

Dr. Omar Zimmo
(Member)



The findings, interpretations and conclusions expressed in this study do not necessarily express the views of Birzeit University, the views of the individual members of the M.Sc. Committee or views of their respective employers.

Table of Contents:

CHAPTER 1.....	12
1.1. Introduction _____	12
1.2. Area of study _____	14
1.3. Topography and landscapes _____	14
1.4. Rainfall _____	16
1.5. Limited water resources _____	16
1.6. Agriculture _____	16
1.7. Relevance and research problem _____	17
1.8. Research question _____	18
1.9. Research objectives _____	19
CHAPTER 2.....	20
2.1. Literature Review _____	20
2.2. Overview on Desalination _____	20
2.3. Desalination Background _____	21
2.4. Desalination in Gaza _____	21
2.5. Desalination of brackish water in Jordan _____	21
2.6. Desalination in Israel _____	23
2.7. Fundamentals of Membranes for Water Treatment _____	24
2.8. Relevant to effluent reuse Agriculture in Jericho _____	24
2.9. Brine effects on soil _____	25
2.10. Desalination effects on Agriculture _____	26
2.11. Cost and Feasibility _____	26
CHAPTER 3.....	28
3.1. Research Methodology _____	28
3.2. Reviewing previous studies _____	29
3.3. Data collection and storage _____	29
3.4. Meetings with stakeholders _____	29
3.5. Field surveys _____	30
3.5.1. Objectives of the survey _____	32
3.5.2. Target _____	32
3.5.3. Sampling Design _____	32
3.5.4. Questionnaire: _____	33
3.5.5. Interview: _____	33

3.5.6. Questionnaire Analysis:_____	33
3. 6. Obstacles and constraints _____	34
3. 7. Data analysis _____	35
CHAPTER 4.....	36
4.1. Baseline Data – Assessment of water quantity in the area of study _____	36
4.2. Existing Wastewater Treatment Plant in the Jordan Valley area _____	60
4.3. Case study - Arab development society (ADS) _____	70
CHAPTER 5.....	83
REFERENCES.....	88

Table of Figures:

Figure 1: Map for the study area (JICA, 2006).....	14
Figure 2: Estimation of agricultural water demand in Jericho area, modified according to (PHG, 2010).	18
Figure 3: Distribution of survey samples in the study area.....	33
Figure 5: Ground Water Wells the Jordan Valley (PWA, 2013b).Desalination in Palestine.....	38
Figure 6: Salinity map for West Bank (PWA, 2012).....	40
Figure 7: Location map for Desalinating projects in the Jordan Valley modified according to (Jericho-Municipality, 2013).....	42
Figure 8: Zbeidt Pilot Project.....	42
Figure 9: Location of Zbeidat Pilot Project	45
Figure 10: Simple Reverse Osmosis System (El-Ghonemy, 2013).	46
Figure 11: Typical schematic diagram of R.O Desalination System(ADAN, 2011).	46
Figure 12: Typical pretreatment possible schemes, Source: (ADAN, 2011).	47
Figure 13: Pre-filtration unit in Zbeidat desalination plant.....	48
Figure 14: R.O unit in Zbeidat desalination plant.....	48
Figure 15: Unti-scalent unit in Zbeidat desalination plant.....	49
Figure 16: PV energy supply system in Zbeidat desalination plant.....	50
Figure 17: Product use in Zbeidat desalination plant.....	50
Figure 18: Location of Marj Na'jeh Pilot plan	52
Figure 19: Pre-filtration unit –Marj Na'jeh plant	52
Figure 20: R.O unit –Marj Na'jeh plant	53
Figure 21: Location of PARC desalination pilot plant(Jericho-Municipality, 2013)	54
Figure 22: PARC R.O Unit.....	54
Figure 23: COPSCO Desalination plant –Jericho.....	55
Figure 24: R.O unit at COPSCO desalination plant.....	56
Figure 25: Location Map for JWWTP, Source: (NJS, 2013).....	61
Figure 26: JWWTP under construction, 2013	61
Figure 27 : JWWTP- Treatment Flow Sheet, Source: (NJS, 2013).	63
Figure 28: WWTP in Jericho Intercontinental Hotel	65
Figure 29: WWTP in Residential Guard compound.....	67
Figure 30: WWTP in Jericho Hospital.....	67
Figure 31: Map for ADS wells, edited according to (PWA, 2013).....	71
Figure 32: Proposed plan for reusing of treated effluent	75
Figure 33: Major wadi basins in the study Area (PWA, 2013).....	77

Figure 34: Map for the catchment area of Jericho Wadi's	78
Figure 35: Schematic Diagram for a proposed Flood Water Harvesting Ponds, Source:(Ridini et al., 2013).	80
Table 1: Land use and Potential Development in Agricultural land extension (JICA, 2006).....	15
Table 2: Operating and planned brackish water desalination plants in Israel (ADAN, 2011).....	24
Table 3:Outlines for the feild survey	30
Table 4: Available Water from Eastern Aquifer in Jordan Rift Valley (JICA, 2006)	36
Table 5: Water Demand for the Jordan Valley Area to the year 2015.....	37
Table 7: Production of Agricultural wells in the Jordan Valley 2009, source: (MoA and PWA, 2010)	37
Table 8:Palestinian Standards for acceptable level of drinkable water (PWA, 2011).	39
Table 9: Quality Parameter's for Feed water (AL-Najah, 2012).	43
Table 10: Quality Parameters for Permeate and concentrate 2011, Source: (Al-Najah University, 2013).....	43
Table 11: Expexted pollutants and their possible treatment processes(ADAN, 2011)	47
Table 12: Raw water analysis for the influent in Marj Na'jeh desalination pilot project, (Abuelhaija, 2013).	51
Table 13: Raw water analysis for the water source at COPSCO RO unit	56
Table 14: Comparison between Raw and Permeate water analysis	57
Table 15: Summary Data for Desalination Plants in the Jordan Valley.....	59
Table 16: Design WWTP Capacity and Treated Wastewater Quality, Source: (NJS, 2013).....	62
Table 17: JWWTP Design, Facilities &Concepts(NJS, 2013)	62
Table 18:Estimated Wastewater Quantity and Quality from JWWTP, Source (NJS, 2013)	63
Table 19: Estimated annual cost and average cost for treated effluent in JWWTP, (NJS, 2013).....	64
Table 20: Capacity and Design Basis(ARGES, 2013).....	66
Table 21: Total Power Consumption for Jericho Hospital WWTP (ARGES, 2013).....	66
Table 22: Chemical and Electrical Consumption / Year Source: (ARGES, 2013).....	67
Table23: Summary Data for WWTP's in the Jordan Valley: Summary Data for WWTP Plants in the Jordan Valley(ARGES, 2013).....	69
Table 24: Land Use at ADS	73
Table 25: Water requirements at ADS	73
Table 26: Estimated quantities of treated effluent generated from JWWTP (NJS, 2013).	74
Table 27: Wastewater quality standards (MoA & PWA, 2013)	75
Table 28: PWA measurment in Wadi Qelt	78
Table 29: BWRO key techno-economic parameters (ADAN, 2011).....	81
Table 30: BWRO plants specific investment (ADAN, 2011).....	82
Table 31: BWRO plants total water costs.....	82
Table 32: Comparison between disfferent alternatives to utilize brackish water at ADS.....	84

List of Abbreviations:

ADS	Arab Development Society
ANERA	American Near East Refugee Aid
AOAD	Arab Organization for Agricultural Development
ARIJ	Applied Research Institute/ Jerusalem
BOD	Biological Oxygen Demand
BWRO	Brackish Water Reverse Osmosis

CM	Cubic Meter
CM/D	Cubic Meter per Day
CMWU	Coastal Municipalities Water Utility
CM/Y	Cubic Meter per Year
COPSCO	Consolidated Palestinian Steel Company
DMP	Desalination Master Plan
EC	Electrical Conductivity
EMS	Emergency Municipal Support
EWI	Environmental and Water Institute
GDP	Gross Domestic Product
IWA	Israeli Water Authority
JAIP	Jericho Agro-Industrial Park
JWWTP	Jericho Waste Water Treatment Plant
KSA	Kingdom of Saudi Arabia
MCM	Million Cubic Meters
MCM/Y	Million Cubic Meters per Year
MBTT	Membrane Based Treatment Technology
MEDRC	Middle East Desalination Research Center
MENA	Middle East & North Africa
MF	Micro Filtration
MoLG	Ministry of Local Government
ND	Not Determined
NF	Nano Filtration
NGO's	Non-Governmental Organizations
NIS	New Israeli Shekel
PARC	Palestinian Agricultural Relief Committee
PPM	Part Per Million
PWA	Palestinian Water Authority
MoA	Ministry of Agriculture
PCBC	Palestinian Central Bureau of Statistics
PH	Power of Hydrogen
PHG	Palestinian Hydrology Group
PPM	Part per Million
PSI	Palestinian Standards Institution
PV	Photo Voltaic

RO	Reverse Osmosis
SBR	Sequenced Bio-Reactors
SMBS	Sodium Meta Bio Sulfit
SPSS	Statistical Package for Social Sciences
SR	Saudi Riyal
SWH	Surface Water Harvesting
TDS	Total Dissolved Solids
TSS	Total Suspended Solids
UF	Ultra Filtration
UNDP	United Nation Development Pregame
UNRWA	United Nations Relief and Works Agency
USAID	United States Agency for International Development
WAJ	Water Authority of Jordan
WBWD	West Bank Water Department
WEAP	Water Evaluation and Planning
WW	Wastewater
WWTP	Waste Water Treatment Plant

Acknowledgements

I would like to express my deep appreciation to my supervisor, Associate Prof. Rashed Al-Sa'ed, for his advice and continuous support throughout the thesis. I also extend my gratitude to the Environmental and Water Institute at Birzeit University who gave me the opportunity to enroll in the master program.

Thanks are forwarded to the Palestinian Water Authority for providing the scholarship and MEDRC for their financial support. I would like to appreciate all EWI program lecturers and supporting staff for their efforts in facilitating this program.

Much gratitude is extended to the people in charge in the Ministry of Agriculture in Jericho who helped me in distributing the questionnaire to the farmers. I also would like to extend my thanks to all interviewees, water professionals and farmers Associations for their time and efforts to facilitate my questionnaire and interviews.

My greatest thanks are also extended to my father and mother who supported me to reach this level of education and to my lovely wife, daughters, and son for their patience, encouragement and continuous support during my research.

Abstract

This research study investigates the feasibility of applying the membrane based technologies for brackish water desalination and effluent reclamation for agricultural use in the Jordan Valley area. The purpose of this research is to identify and evaluate additional water resources to alleviate the water shortage in the Jordan Valley.

The ground water in the Jordan Valley is characterized as brackish water. About 10-12 MCM/Y of brackish water are extracted by the Palestinians from Jordan Valley wells and used for agriculture. This quantity is expected to be improved by additional 6 MCM/Y by developing the old existing wells. The PWA and the MoA estimated the shortage in water demand for both domestic and agriculture uses in the year 2030 of more than 60 MCM. On the other hand, optimistic water quantities are still available for development such as the brackish water from Fashkha and Malih springs 81–101 MCM/Y and 4 MCM/Y of runoff water harvested from the wades. Furthermore and by the end of 2014, Jericho wastewater treatment plant (JWWTP) will be generating 2450 cubic meter per day (CM/D). This quantity will be gradually increasing to reach its maximum capacity by 2025 with 9900 CM/D which equals to 3.6 MCM/Y of treated effluent water from Jericho sewage collection and treatment system which can be considered as an alternative option to reduce the gap between available resources and the growing demand for Agricultural water in the Jordan Valley.

Currently 21800 ha of irrigated lands are used for agriculture whereas, 221 ha are still available for development.

The research methodology was based on evaluating the available brackish water quantities in the study area, collecting baseline data on existing desalination and wastewater treatment plants in the study area, evaluating beneficiary's awareness and perception to use desalinated brackish water and treated effluent, this was measured by designing, distributing and analyzing a questionnaire survey to the target beneficiaries, Furthermore, a total of 162 wells (annex 1), 4 desalination plants (annex 2) and 6 wastewater treatment plants have been surveyed (annex 3).

The research has examined several alternatives for utilizing the brackish water and treated effluent in the Jordan Valley.

The research concluded that the use of reverse osmosis (RO) technology for treating brackish water wells in the Jordan Valley is the most feasible alternative comparing with other desalination technologies, RO will be more feasible when combined with other alternatives to minimize the cost and improve the efficiency such as blending the brackish water with treated effluent generated from wastewater treatment plants (WWTP) or blending with runoff water harvested from neighboring Wadies and also by utilizing the Photo Voltaic power (PV) to minimize the energy cost produced by traditional power sources.

The feasibility of the Membrane Based Treatment Technology (MBTT) has been examined by evaluating the available resources for agricultural water including the potential for future development whereas, financial feasibility has been evaluated by comparing the cost of R.O desalination using two different sources for power supply such as public electricity grid to the off-grid connected RO-PV, also to the cost when blending the brackish water with treated effluent or harvested runoff water.

Comparison was tested on an operating desalination plant in Zbeidat village. The calculation has shown that the average produced water cost estimated to be \$ 0.083 (USD)/CM for RO-PV desalination compared to \$ 0.166 (USD)/CM estimated if power obtained from public electricity network as per calculated by (Taha, 2014) in Marj Na'jeh R.O unit.

By giving the fact that the baseline data for this research based on the assessment of farmer's and public perception for reusing of desalinated water and treated effluent, a field survey's has been conducted in order to analyze the existing situation, understand the needs and define gaps in the existing agricultural water management pattern. Several parameters has been measured and data were collected by means of questionnaire designed based on a set of predefined indicators related to the study. The survey analysis showed a low level of awareness on desalination and effluent reuse, high rejection to the treated effluent when used directly but less rejection when effluent blended with desalinated or run-off harvested water. Most farmers considered that the best affordable price for agricultural water should not exceed 0.2 – 0.4 NIS equals to \$ 0.056 – 0.11 (USD) . The results showed that most of the farmers have average potential for land development between 2-6 hectares.

The research taken the wells in the Arab Development Society (ADS) as a case study. ADS is the biggest farmers associations in the Jordan Valley located to the east of Jericho city near the border with Jordan where the high salinity water exists. ADS extends on 7500 ha and owns 24 wells of licensed abstraction of 1.2 MCM/Y, however only 4 wells are operated with average abstraction of 0.631 MCM/Y, other wells are abandoned and requires rehabilitation.

The alternatives proposed for the Arab Development Society wells can be disseminated and applied on all saline agricultural wells in the Jordan Valley in order to overcome the problem of salinity and stop the damage to the soil and crops.

By comparing the research results with the corresponding ones obtained from similar researches showed an acceptable agreement with strong proof that desalination cost has come down and the efficiency improved in the past twenty years.

The final conclusion of this research that the most feasible option to utilize the brackish water in the Jordan valley is by combining the RO technology by other alternatives such as blending with treated effluent or run-off water, Nevertheless, a further investigation on the desalination design capacity and efficiency is still needed as well as the environmental impact of RO, brine disposal and effluent reuse.

Chapter 1

1.1. Introduction

Water scarcity, increasing population, economic growth, pollution, and urbanization are all placing permanent threat to freshwater resources. The gap between supply and demand on freshwater for industrial, agricultural, and domestic use in Palestine and the surrounding Middle East countries is growing at an alarming speed. Meanwhile, in Palestine there is a 100 -110 CM/Y of potential brackish water resources available and discharged to the Dead sea (PWA, 2012) and by the end of 2014 a minimum of 2450 cubic meters of recycled water will be generated by Jericho wastewater treatment every day. This quantity will increase gradually to reach its maximum in 2025 with 9900 CM/D.

Water, which is one of the most valuable natural resources in the Middle East, is currently facing many challenges as the population growth, economic and agriculture development, and an arid climate results in overexploitation of the water resources in the region. These challenges lead to a rapid degradation of the quality of fresh-water resources. Additionally, as a result of the Stalinization and contamination processes (Vengosh and Rosenthal, 1994), rising salinity levels becomes one of the significant signs of water-quality degradation in groundwater. The alluvial Pleistocene wells in the Jericho area/Palestine show high salinity and a high susceptibility to contamination (Khayat et al., 2006).

The salinity caused by natural and anthropogenic sources is threatening the fresh-water resources. A natural reason is that the overexploitation of fresh aquifers results in a rapid decrease of water levels, which then allows lateral as well as upwelling of deep saline waters from neighbouring aquifers. As a result, the overexploited aquifers become saline due to the leaking of salty water (Vengosh and Rosental, 1994).

Responding to the challenges mentioned earlier, some innovative measures and creative initiatives should be considered. The use of reclaimed effluent and the membrane based desalinated technology for brackish water is growing worldwide and the cost of desalination has decreased steadily in the last few years. Desalination becomes a viable solution for water problems.(ADAN, 2011).

The wise application of innovative water and wastewater treatment systems using membrane based treatment technologies improve water independence, food security and economic development in Jericho district.

There is also a need for water management and rational use of water. This implies looking for new resources for potable water and making use of new efficient and effective technologies. There are several aspects for the importance of reclaimed effluent reuse and desalination to provide a future answers for water needs.

This research is going to introduce the assessment of applying the MBTT and the reuse of reclaimed effluent in providing a feasible and sustainable method to utilize brackish and reclaimed effluent in the Jordan Valley area; this is expected to be helpful in improving the water supply that meets the growing demand for drinking, agriculture and industry.

The amount of the available brackish water controls the efficiency of using this technology, in the Jordanian trial the total average flow of brackish springs was 46 MCM/Y and the use of desalination in Jordan is limited to few cases (Mohsen and Al-Jayyousi, 1999).

Palestine is well-known for using the RO technique in desalinating water. In 1993 the first RO desalination plant was established by EMS in Gaza, and followed by two RO plants constructed by Italian development cooperation program, the number of plants keep on growing to reach about 50 units to provide 2 MCM/Y (Ahmed, 2010)., Gaza still lacks an integrated water management system which causes big waste of the available investments, in spite of its precedence in using this technique (Salah et al., 2010).

Decreasing of the water level in Gaza aquifers leads to intrusion of sea water to the aquifer changing 80% of its water to brackish water (Saleh, 2007). Also the untreated wastewater plays major role in increasing the ground water salinity, through 363 sites in Palestine the untreated wastewater is discharged into the environment which plays major role in increasing the ground water salinity (PWA, 2006).

Desalination has become a component of the strategic plan of the Palestinian Water Authority, since the projected domestic water demand by year 2020 is about 182 MCM(PWA, 2006). In Palestine, the experience in desalination using reverse osmosis [RO] technology is new. The first RO plant was constructed in Deir El-Balah, Gaza Strip. People in Gaza have become aware of the deterioration of the quality of the municipal water supply, so they have started to install RO domestic units to solve their problem individually. PWA according to its policy decided to increase the unconventional water resources through adoption of desalination options (Ismail, 2003).

In West Bank the desalination technology is used in Jericho governorate (Jordan Valley) only where brackish water exists in some water wells in the area; most of these desalination projects has been constructed for scientific and experimental purposes.

1.2. Area of study

The area of study is the Palestinian Territories, particularly the Jordan Valley area where brackish waters are viewed as potential and viable resources to alleviate water scarcity and overcome water budget deficit.

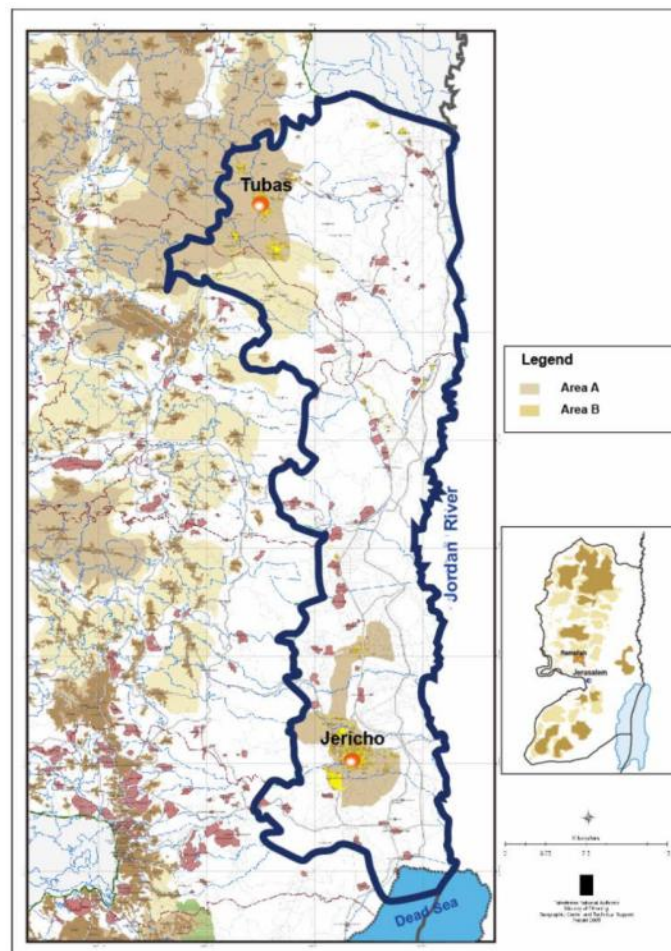

Figure 1: Map for the study area (JICA, 2006).

1.3. Topography and landscapes

The area of study slopes gradually from west to east. The mountainous area is located in the upstream of Wadi Far'a. The elevation reaches up to 600 m above sea level. Most of all study areas are covered by foothills with steep slopes, the elevation of the foothills range from 0 to 200 m above sea level. Flat area, which is lower than the sea level and has relatively high agricultural resources, lies along the Jordan River. The length and width of the area is about 10 km and 1 to 2 km, respectively (NIPPON KOEI CO., 2008).

Table 1: Land use and Potential Development in Agricultural land extension (JICA, 2006)

1	2			3	4	5=3+4	6
	Area (Km ²)			Agricultural Area (Km ²)	% of West Bank area	% of Area C in Jordan Valley	Natural Reserve Area (Km ²)
	Area A+B	Area C	Total				
Bardala / Kardala and Wadi Malih	0	275	275	21 (7.6%)	93 (33.8%)	114 (41.4%)	58 (21.0%)
Wadi Far'a and Jiftlik	87	129	216	110 (51.0%)	40 (18.5%)	150 (69.4%)	24 (11.1%)
Greater Jericho	69	278	347	87 (25.0%)	88 (25.3%)	175 (50.4%)	18 (5.1%)
Total	156	682	838	218	221	439	100

1.4. Rainfall

The average annual rainfall is 168 mm in the Jordan Valley area, 240 mm in Wadi al Far'a, 429 mm in Tubas, and 554 mm in Jerusalem. The coolest month is January with the mean temperature of 13.3 ° C in Jericho, 14.4° C in Wadi al Far'a, 8.7° C in Jerusalem, while the warmest month is July or August with the mean temperature of 30.0° C in Jericho, 31.4° C in Wadi al Far'a, 23.8°C in Jerusalem. (ARIJ, 1998).

Although the Jordan Rift Valley is extremely dry and surrounded by desert, some areas have groundwater or spring water cultivated by orographic rainfall of the central highlands to sustain agriculture in the Valley. In addition, the warm climate even in the winter makes the valley agriculturally and touristic competitive. (ARIJ, 1998).

1.5. Limited water resources

The West Bank consumes 89.14 MCM/Y, whereas in the Jordan Rift Valley area it is 52.12 MCM/Y, which represents 58% of the West Bank. Likewise, in the West Bank, the optimum water use with leaching requirements is calculated to be 98.14 MCM/Y, and in the Jordan Rift Valley area, 60.24 MCM/Y or 61%. It is clear that irrigation water use in the Jordan Rift Valley area is more than one half of the total in the West Bank, this is due to the fact that the areas with high potential groundwater are located along Wadis, especially as the existing springs and wells are concentrated in lower Wadis. For example, in the Jordan Rift Valley area the annual rainfall is approximately 200 mm. This is the main reason for the high irrigation rate, to make agriculture possible (ARIJ, 1998).

Despite the fact that the Jordan Rift Valley area uses more than one half of all irrigation water, efficiency of irrigation water use in the region, measured in terms of water used per unit area, is the lowest in the West Bank. The urgent challenge then is for the people in the Jordan Rift Valley area to use their limited water resources efficiently in order to maximize their income and employment, while also protecting and restoring the natural environment. In this context, the government should intervene to regulate water usage, to stimulate more efficient use of water resources and to assure sustainability of water resources for future generations (ARIJ, 1998).

1.6. Agriculture

Due to the low quantities of water available to Palestinian farmers, only 6.8% of the cultivated land in the West Bank is irrigated (Brown and Crawford, 2009).

Half of the total agricultural production in the West Bank is from this irrigated land (FAO, 2012). Israel consumes at least ten times more water for agriculture than Palestinians (WB, 2009) irrigating more than half of its cultivated land (IEICI, 2013).

Illegal Israeli settlements in the Jordan Valley grow crops that require large amounts of water, such as bananas, using most of the water pumped from wells in the West Bank; settlers in the Jordan Valley use 81 times more water per capita than Palestinians in the West Bank. (B'Tselem, 2011). Up to \$ 500 million (USD) of Israeli settlement products, most of which are agricultural, enter the Palestinian market every year; with total Palestinian agricultural production only about \$ 342 million (USD) in 2011 (Oxfam, 2012).

It is estimated that if Palestinians were allowed a fair share of water resources and if restrictions in area C were lifted, an additional agricultural production worth \$ 1.22 billion (USD) could be generated yearly (ARIJ, 2011).

1.7. Relevance and research problem

In general, Palestine is facing a water crisis reflected in limited access to available water resources. The Jordan Valley in specific is facing a challenge of water quantities and qualities. Increased annual demand for agricultural water threatens both water volume and quality. Over extraction of groundwater wells led to reverse drying and deterioration in water quality by increasing the salinity level. On the hand, it is clear that water desalination will be the future solution for solving the deficiency in water supply.

Analysis of literature review and references revealed the following problems in the development of the agricultural sector in the Jordan Valley area:

- Increasing demand for domestic freshwater with increased irrigation water for agriculture
- High salinity of ground water wells in Jordan Valley area (1000 – 10000 ppm)
- Crops damage due to high TDS in irrigation water and soil salinity (Pitman and Läuchli, 2002, Medina, 2004).
- Use of desalinated brackish water alone or blended with treated wastewater is not explored in the Jordan Valley and brine disposal is another challenge.
- Lack of funds to implement such recycling facilities where agricultural use of treated wastewater from Jericho wastewater treatment plan is planned.
- Lack of public awareness on potential uses of brackish water and reclaimed water membrane based treatment.

Figure 2 illustrates in brief the above mentioned problems.

Problem

Agricultural Demand: East of Jericho City (Agricultural wells – Do Nothing scenario)

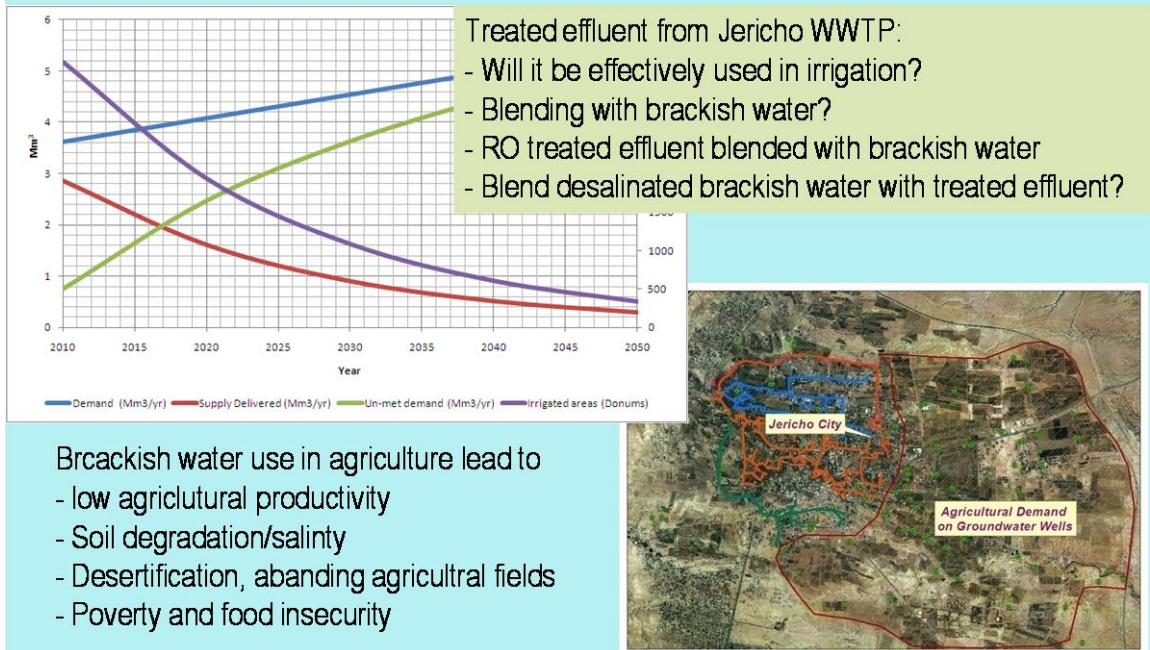

Figure 2: Estimation of agricultural water demand in Jericho area, modified according to (PHG, 2010).

1.8. Research question

- Considering the available brackish water quantities in the Jordan Valley, will the RO technology be a feasible option for agricultural water production?
- What are the guiding principles behind an adequate blending process?
- Could the reverse osmosis technology prove successful in Palestine as it has been in many Middle East countries?
- Will the people accept desalinated water as alternative water source for domestic, industrial and agricultural consumption?
- What should be the quality guidance for blending waters added post-desalination for stabilization?

1.9. Research objectives

- Evaluating brackish water and reclaimed effluent quantities in the area of study and evaluating the feasibility of membrane based treatment technology and other alternatives for brackish water desalination in the Jordan Valley.
- Assessing farmers' perception for using desalinated water and reclaimed effluent in agriculture.
- Evaluating new alternatives to reduce water withdrawals from the country's overdrawn natural storage bodies of potable water (the two main aquifers) to avoid their further degradation by saline water intrusion (some of it irreversibly) and, eventually, raising their levels to hydrological safe values.
- Reviewing of international standards and guidelines for water quality parameters suitable as for irrigation and acceptable by farmers

Chapter 2

2.1. Literature Review

In this context an extensive literature review pertaining the water effluent and desalinated brackish water reuse has been found. The literature review indicates that there are promising amounts of brackish water in the Palestinian territories mainly in the Jordan River Valley, West Bank and in parts of Gaza strip. Desalination of water proved to be efficient by the use of the reverse osmosis technology. This technology proved to be attainable and applicable in many countries in the region.

2.2. Overview on Desalination

This important and critical area of study has witnessed much interest on the part of researchers and the people concerned in water management. (Dreizin et al., 2008) pointed out that desalination which is separating pure water out of the salt water of seas, brackish aquifers, and wastewater is a great step, This exotic water source with membrane technologies improving and the costs of desalinated water dropping is fast becoming an integral part of Israel's water system. The Ashkelon plant, for example, the first of five new facilities planned in Israel, is the largest reverse osmosis plant in the world, producing 100 MCM/Y, or 15% of the total domestic demand. This plant's successful operation has started to shift the perceptions and decisions of the water community in Israel, and some expect Israel to finally derive half of its water from desalination.(El-Bana, 2000) explained that desalination is expected to participate in solving the water shortages especially in dry regions along seacoasts. But in cities far from a seacoast or in mountains the process will be more costly. Nevertheless, desalination is still considered as the only realistic and best technological hope for dealing with fresh water shortages. Over the past forty years, its uses have grown, particularly in the Middle East with two-thirds of the world's 7500 desalination plants.

The great demand of a safe, sustainable, affordable, and adequate water supply for the world is fostering a renewed interest in desalination and other water treatment technologies(California Coastal Commission, 1993). For this reason a number of technologies have been developed for the desalination of high salinity water, and the selection of the right process requires careful evaluation of process efficiency, plant capital and running costs (Bryant, 1992).

The choice of the desalination process can be determined according to site conditions, applications and local circumstances. Also, use of renewable energy compared to other options can reduce the cost of desalination (Kazmerski, 2011).

2.3. Desalination Background

(Domingo Zarzo Martinez, 2009) has pointed out that the investment costs for brackish water desalination as well as the water production costs, are in general lower than the cost for other applications (drinking water, industrial water), fundamentally based in some reasons: (1) Limited requirements of personnel, chemicals, membrane replacement, (2) Possibility to regulate water production according to electrical tariffs in order to produce water at lower energy cost, (3) Lower requirements about product water salinity (4) Lower requirements of civil works, automation, safety measures to guarantee production.

2.4. Desalination in Gaza

Al-Agha and Mortaja (2005) wrote an article in which they address desalination water management in its embryonic stage in the Gaza Strip. The sources of drinking water supply, distribution system and the environmental impact of brine water were explained in detail. They also talked about the importance of desalination as a solution to the great demand on drinking water in Gaza.

Abu-Jabal et al. (2001) said that the water research center in Al- Azhar university in Gaza with the help of the Ebara Corporation (Tokyo) are doing a great contribution to solve the drinking water in Gaza by using the solar energy and evaporation distillation with triple-effect evaporators.

According to the (Bank, 2009) a small scale desalination – largely private – has emerged as a stop-gap solution. In addition to four public desalination plants run by the Coastal Municipality Water Utility (CMWU) (Production 1000 CDM), there are at least 40 private desalination plants selling water both wholesale for delivery by tanker and retail by jerry can (production about 2,000 CDM).

Most of the private facilities are not licensed by the PWA and even those that are licensed are not monitored, as the water authorities do not have the capacity to monitor the many small facilities. There are also thousands of home desalination plants, which are similarly unmonitored (Amnesty, 2009).

2.5. Desalination of brackish water in Jordan

Jordan experience in brackish water desalination with the assistance of Japan international cooperation agency (JICA) has been discussed by (Jaber and . Mohsen, 2001), (Mohsen and Al-Jayyousi, 1999). They said that although this experience is still limited but they expect more and more interest in this field in the near future.

Mohsen and Gammoh (2010) explained that RO desalination systems are used in the Middle east for getting water as well as oil. They added that desalination of sea water

or brackish water is very limited because the Gulf of Aqaba is very far from the Amman where pumping costs a lot of money.

Mohsen and Al-Jayyousi (1999), (Al-Hadidi, 1999) shared the same view above that desalination is the future solution for the problem of the limited sources of water

Table1: Water desalination projects in Jordan

No.	Station	Govt.	Treatment method	Treated water quantity CMH	Capital cost/JD	Finance	Date of est.
1	Ruwaished	Mafraq	Desalination	90	140000	WAJ	2000
2	DeirAlla	Balqaa'	Desalination	50	120000	WAJ	2001
3	Zarqa	Zarka	Desalination	600	750000	WAJ	2002
4	WadiAraba	Aqaba	Desalination	35	120000	WAJ	2002
4	Abu Al-Zegan	Balqaa'	Desalination	1800	2500000	Economic and Transformation Prog.	2003
5	Safawi	Mafraq	Desalination	55	194000		WAJ
6	Al-Omari	Aqaba	Desalination	30	87000	WAJ	2003
7	Mobile unit	Mafraq	Desalination	35	89500	WAJ	2003
8	Mobile unit	Ghor	Desalination	35	87500	USAID	2003
9	Mobile unit	Balqaa'	Desalination	35	87500	USAID	2003
10	Qatar	Aqaba	Desalination	3.5	---	USA govt.	2003
11	Ghor Safi	Karak	Desalination	75	128000	WAJ	2005
12	Ain Sara	Karak	Desalination	55	74000	WAJ	2005
13	Jafr	Ma'an	Desalination	35	134700	Royal Court	2007
14	Al-Gweibeh	Karak	Desalination	15	49000	Ministry of finance	2007
15	Al-Karama	Mafraq	Desalination	18	119000	Free Zone Corporation	2007
16	Border						
16	GhorFifa	Karak	Desalination	30	99000	Ministry of finance	2008
17	Al-Kraymeh	Balqaa'	Desalination	100	147000/year	WAJ	2008
18	Al-Rwaished	Mafraq	Desalination	70	102000	Ministry of finance	2008
			Total	3166.5			

2.6. Desalination in Israel

Israel started its implementation of water desalination by the mid-1950s when it extended irrigation pipes to the Negev desert, by this time, desalination had already been employed for drinking water in Eilat. In the late 1950s the Israeli government was presciently investing a relatively large amount on R&D on desalination (Tenne et al., 2012).

Desalination Master Plan (DMP) for the Israel Water Authority's (IWA) in 1997 which was prepared by ADAN Technical & Economic Services Ltd. (ADAN). And discussed by Tenne et al. (2012) has discussed the capacity, location and product water quality of the three large-scale seawater desalination plants currently operating in Israel, Ashkelon, Palmachim and Hadera. In addition, he mentioned that there are two other plants currently under construction, Soreq A and Ashdod, as well as the two plants which are foreseen to be installed by 2020, Western Galilee and Soreq B.

The costs analysis which were driven by the hope to minimize the total investments has been discussed by (Tenne et al., 2012). The cost analysis included the investments in the plants themselves, through economies of scale and utilization of existing infrastructures, and in the investments in the downstream infrastructures that would be required to continuously absorb the desalinated water. The benefits analyses were made in the hope to get the maximum value of desalinated water quantitatively by increasing the reliability of the water supply and qualitatively, increasing GDP and avoiding water withdrawals from the country's overdrawn natural storage bodies of potable water and qualitatively by reducing water supply hardness and lowering the chloride and sodium concentrations in the reused municipal wastewater.

Table 2: Operating and planned brackish water desalination plants in Israel (ADAN, 2011)

No.	Plant name	Plant owner	Flow rate CMD	Year of Establishment
1	Sabaha A	Mekorot	28,000	1978
2	Sabaha B	Mekorot	10,000	1993
3	Nawe zohar	Mekorot	13,000	2003
4	Kziot	Mekorot	8,600	2003
4	Granot	Mekorot	7,400	2003
5	Gat	Mekorot	4,500	2004
6	Magan Misheal	Magan Misheal	25,000	2004
7	Nawe yam	Nawe yam	6,500	2005
8	South-Hof carmel	--	14,000	2005
9	Hof carmel	Hof hakarmel	3,600	Planned
10	Naaman Kordani	--	15,000	Planned
11	Lahat	Mekorot	18,000	2011
12	Mishor rotem	Mekorot	30,000	Planned
13	Mainot zokim	Mekorot	5,000	Planned
14	Beer ora	Mekorot	6,000	Planned
Total brackish water - active			31.3 MCMY	94,850 CMD
Total brackish water - planned			33.7 MCMY	102,100 CMD

2.7. Fundamentals of Membranes for Water Treatment

The history of development and importance of membranes for water purification was investigated by (Zahid Amjad, 1998). They started very traditional and ineffective and ended very advanced and productive. He also talked about three types of membranes: microfiltration (MF), Ultra-filtration (UF), reverse osmosis (RO), and Nano-filtration (NF) membranes; each one of these has its own characteristics.

2.8. Relevant to effluent reuse Agriculture in Jericho

The challenges of waste water management in Jordan valley was discussed by (Al-Sa'ed, 2006). He discussed the existing WWT facilities in Palestine and the potential use of treated wastewater for agriculture. While (Shaheen, 2003) investigated the economic feasibility of wastewater reuse. He distributed questionnaires to farmers and inhabitants in different areas of the West Bank to elicit social acceptance. Wastewater reuse can cover about 10 percent of irrigated agriculture, which contributes 35 percent of the total value of the Palestinian agricultural sector. (Hochstrat et al., 2006) pointed out that recycled water may be the solution of the shortage of water in the future

which is a significant low-cost resource development option for agricultural, industrial, and urban potable/non-potable uses. In addition, wastewater collection and treatment is essential to protect public health and prevent environmental pollution. while (Jimenez et al., 2001) emphasized the importance of recycling water for agriculture and irrigation, but he explained that three factors should be considered: pathogenic microorganism content, salinity, and soil permeability.

Lawrence et al. (2003) emphasized the importance of water reuse projects to cope with the increasing need of water in the arid regions. The success of these projects depends on both the effectiveness and the suitability of the technology and the safety and the efficiency of the distribution. Two examples are mentioned to prove the success of water reuse projects: the first in Egypt and in USA.

The success of treated water re-use schemes does not just depend on the effectiveness and suitability of the technology that treats the wastewater. The planning and development of the institutional framework that will monitor control and deliver the treated wastewater — particularly where there are many institutions working in the same or similar areas — is vital for the safe and efficient use of this increasingly important water resource (Lawrence et al., 2003)

Jimenez et al. (2001) also emphasized the importance of recycling water for agriculture and irrigation, but he explained that three factors should be considered: pathogenic microorganism content, salinity, and soil permeability.

In the Master Plan study for Jericho Water System, (PHG, 2010) has collected and analysed important data on farm water use practices and the farmers' perspectives on relevant issues. During this Research several surveys and workshops has been conducted in order to assess the willingness of farmers to use recycled water or blended effluent. The report has provided additional data on the available water quantities for both domestic and agricultural consumption as well as the Physical and Chemical characteristics of ground water in Jericho area.

2.9. Brine effects on soil

Brine has physical and chemical effects on soil. First, it damages the soil's physical properties by increasing the concentration of the sodium accumulated on the surface. In addition, the soil fertility is affected as the high temperature of brine kills microorganisms in soil. The soil is also affected chemically because brine has toxic materials that can damage the structure and composition of soil. It may also affect the soil's capacity to hold water and to transmit plant nutrients. Consequently it will result in a poor soil quality which will definitely affect crop yields (Jimenez et al., 2001).

2.10. Desalination effects on Agriculture

Blending of desalinated with saline groundwater to compensate the essential nutrients lost through RO was investigated by (Ben-Gal et al., 2009) . They found that blending 30% saline water with 70% desalinated water brought Ca, Mg, and S minerals to satisfactory levels.

2.11. Cost and Feasibility

In order to integrate the different elements of the problem (Georgopoulou et al., 2001) wrote a paper in which he outlines a methodology that allows the use of desalinated brackish groundwater, coupled with an effective strategy for controlling seawater intension and enhancement of the hydrologic budget through reuse of treated wastewater into an optimization shell package that can be used for the economic evaluation of the overall scheme and presents some aspects of two of the system elements, brackish water desalination and recharge with treated wastewater

In Al-Jouf area in KSA (El-Ghonemy, 2013) conducted a study about getting the underground water and desalinating it using public electricity or diesel generators in remote areas to drive various types of pumps. In this research he proved that a small scale RO desalination unit is very common in use for producing fresh water from brackish water. (El-Ghonemy, 2013) found out that, specific power consumptions are 3.99 and 3 KWh/CM based on installed and actual power consumption respectively. Moreover, from the cost analysis, the percentage costs are; 49.4%, 28.66%, 8.47%, 8.4%, 5% for labor cost, chemicals cost, electric power cost, fixed cost, and membrane replacement cost respectively. Also, the production cost resulting from the small BWRO desalination unit is estimated to be 7(SR) /m³ (about \$ 2 (USD) / CM).

The feasibility of the off-grid connected RO-PV (to operate the desalination unit) was compared to Diesel generator and electricity network by (Taha, 2014), environment cost was included. Comparison was tested on operating desalination plant in Marj Na'jeh. The economic calculation has shown that the average produced water cost estimated to be \$ 0.166 and 0.346 (USD)/m³ estimated if electricity network or Diesel generator.

The cost of BWRO desalination has been estimated by (Glueckstern, 1991), he found that the cost of 1 CM of desalinated water for a 12,500 CM/D capacity BWRO plant is ranges between \$ 0.47-0.64/ CM and the investment costs for relatively high saline surface brackish water is approximately \$1000 (USD)/ CM/D compared to \$ 500 (USD)/ CM/D and unit water cost \$ 0.34 - 0.40/ CM for a 25,000 (USD)/ CM/D capacity plant with low salinity water while the specific energy consumption is estimated to 20% of the unit water cost.

Another example has been taken is the (Sabha) brackish water desalination plant of capacity 13,500 (USD)/ CM/D. This plant located in Eilat at the Red Sea shore used

to supply 50% of the city water demand. by comparing the operation cost in this plant it was found that the cost has been dropped down from 0.49 in 1981 to 0.3 in 1984 and 0.23 in 1985 with a possibility for further improvement to \$ 0.1- 0.2 (USD)/ CM by interconnection with coal, nuclear or solar-pond power stations.

Chapter 3

3.1. Research Methodology

The following research methodology was applied to achieve the study objectives:

- Data collection from many sources including the following:
 - Relevant review of literature
 - Data at the governmental and non-governmental institutions including the Palestinian Water Authority (PWA), Ministry of Agriculture (MoA), Jericho Municipality, the Palestinian Central Bureau of Statistics (PCBC), the Palestinian Agricultural Relief Committee (PARC), Applied Science Research Institute in Jerusalem (ARIJ) , Birzeit University and Middle East Desalination Research Center (MEDRC).
 - Interview and personal communication with key persons and experts.
 - The questionnaires distributed to the stakeholders including farmers and major wastewater generators.
- Evaluation of quantity and quality of ground water in the Jordan Valley area (potable & agricultural uses)
- Assessment of land available to increase the potential of agricultural land
- Evaluation of current desalinating technologies including pilot scale units in Jericho District
- Develop, distribute, collect and analyze field questionnaires pertinent to perceptions and attitudes of farmers, households and general public
- Investigating two case studies (effluent of Jericho WWTP and existing RO systems in Jericho)
- All compiled data were then entered into a special geo-data base that was developed for this research in order to facilitate data management, handling and retrieval. The geo- database includes several types of information related to the water in the area of study.

The Gio-data base includes maps, aerial photographs, location of groundwater wells, potential abstraction, topography, land uses. wells data, location of desalination and wastewater treatment plants, location of springs and their potential discharge, the main streams and their potential flow and many other types of data.

- The economic analysis including estimation of the Total Costs according to the following equation:

$$\text{Total Cost} = \text{Investment Cost} + \text{Operation and Maintenance Cost} + \text{Environment Cost}$$

, (Abu Madi, 2005).

Where,

- Investment cost is inclusive of desalination and Photovoltaic system cost, and was referred to different previous studies and living examples from Zbeidat, , COPSCO and desalination plants and also by referring to the calculations made by (Taha, 2014) for Marj Na'jeh R.O plant.
- Operational and maintenance cost that includes: labor, operational material, testing, replacement of filters, invertors, and batteries (Taha, 2014).
- Cost treated effluent from JWWTP
- The produced water estimation cost is calculated using the following equation

- The average produced water Cost $\left(\frac{\text{USD}}{\text{m}^3}\right) = \frac{\text{Total Cost}\left(\frac{\text{USD}}{\text{year}}\right)}{\text{Total Produced Water}\left(\frac{\text{m}^3}{\text{year}}\right)}$ (Abu Madi, 2005).

3. 2. Reviewing previous studies

As Jericho and the Jordan valley have been a center of interest for a number of organizations working in this sector, a number of publications have been produced relevant to this research; these publications have been collected and reviewed at the very beginning of this study.

3. 3. Data collection and storage

Relevant data on population and socio economic aspects have been provided by the central bureau of statistics (PCBS) while the data relevant to water resources, climate, soil and agriculture have been provided by the Palestinian water authority (PWA), the Ministry of Agriculture (MOA) and Applied Research Institute - Jerusalem (ARIJ). Moreover, it compiled several sets of data related to water use, water supply system details, and water - wastewater tariff and water governance from Jericho Municipality.

3. 4. Meetings with stakeholders

During the study, I have conducted several meetings with potential stakeholders in Jericho in order to understand the current situation and to assess the roles and relations of those stakeholders in managing agricultural water in the area. The following were the main stakeholders that were met: Jericho Municipality, Ein Sultan Irrigation Association, Ministry of Local Government (MoLG), Ministry of agriculture (MoA) and the Palestinian Agricultural Relief Committee (PARC) and other individual farmers.

These meetings were necessary to assess the current situation and to introduce the desalinated brackish water and effluent reuse in agriculture as a new potential water source for agriculture and also to better understand how stakeholders can be engaged in this process.

3.5. Field surveys

Knowing that part of the baseline data depends on the assessment of farmers' and public perception for reusing desalinated water and treated effluent, field surveys have been conducted to analyze the existing situation and to understand the needs and define gaps in the existing water management pattern. Accordingly, several areas to be investigated have been identified. Data were collected through a questionnaire that was designed based on a set of predefined indicators related to:

- Socio economic background: it includes aspects about demography (age/sex and permanent residents) and socio economic variables (education, employment status, average annual income and average annual expenditures for agricultural water).
- Quantity and quality of agricultural water supply: questions about the current water status such as water resources, interruption of water supply, availability of agricultural land and actual water demand in order to assess the satisfaction degree.
- Water supply cost: questions about cost and tariff for agricultural water in addition to farmers' affordability for Agricultural water price.
- Water related practices: include questions related to irrigation methods, types of cultivation, availability of water saving methods and salinity tolerance crops, willingness to pay and the satisfactory price of agricultural water.
- Assessing the farmers' acceptance to use desalinated water and treated effluent
- Perspective of problems which most farmers are suffering from, causes and solutions for those problems. (See questionnaire in Annex 4)

Table 3: Outlines for the field survey

Number of Samples	Jericho City	15 Respondents
	Jericho Governorate ¹	35 Respondents
Survey Method	Interview Survey	
Sampling Method		

Main Questions	General Articles of respondent	<ul style="list-style-type: none"> ➤ Age ➤ Gender ➤ Location ➤ Education ➤ Career
	Water Situation	<ul style="list-style-type: none"> ➤ Water Source ➤ Average annual cost for agricultural water ➤ Average annual consumption of agricultural water
	Satisfaction to agricultural water from respondent point of view	<ul style="list-style-type: none"> ➤ Level of satisfaction to water quantity ➤ Level of satisfaction on water cost ➤ How does water cost affect the production ➤ Suitable price from respondents point of view ➤ Satisfactory percentage from total income to be deducted as water cost ➤ The actual percentage form total income which is currently deducted as water cost
	Knowledge on Desalination & Effluent Reuse	<ul style="list-style-type: none"> ➤ Awareness level on Desalination and Effluent reuse
	Land availability and potential for improvement	<ul style="list-style-type: none"> ➤ Available cultivated land ➤ Available water quantity ➤ Potential land availability for future development
	Water Quality	<ul style="list-style-type: none"> ➤ Current salinity level of the water source ➤ Acceptance for reusing the treated effluent to bridge the gap between the demand & supply. ➤ Reasons behind the rejection of the reuse of treated effluent ➤ Acceptance for reusing the desalinated water to bridge the gap between the demand & supply. ➤ Acceptance of blended water (brackish & treated effluent) ➤ The reasons behind accepting the reuse of treated effluent, brackish or blended water . ➤ Expected side effects for desalination.
	Feasibility of treated effluent reuse and desalinated water	<ul style="list-style-type: none"> ➤ Impact of reusing treated effluent and desalinated water on crops yield in term of quality and quantity. ➤ Satisfaction to the fact that reusing of treated effluent and desalinated brackish water is enough to cover the shortage in agricultural demand.
	Farm management	<ul style="list-style-type: none"> ➤ Type of cultivation ➤ Irrigation method ➤ Existence of Problems in Irrigation system referred to the water quality. ➤ Main obstacles countering the agriculture development in the Jordan Valley.

3.5.1. Objectives of the survey

- Understanding the current agricultural water situation in the Jordan Valley area
- Assessing the satisfaction level to the agricultural water supply in terms of quantity and quality.
- Questions about the current water resources, interruption of water supply, availability of agricultural land and actual water demand.
- Water supply cost; questions about the cost for agricultural water and farmers' affordability to pay.
- Water related practices: questions related to the irrigation methods, types of cultivation, availability of water saving methods and salinity tolerance crops, willingness to pay, the satisfactory price of agricultural water.
- Assessing the farmers acceptance and willingness to use desalinated water and treated effluent
- Defining targets for future awareness activities by analysis of respondents' opinion.

3.5.2. Target

50 persons were selected for interview. Among the fifty, fifteen are from Jericho City, and thirty-five are from surrounding areas of Jericho city (Jericho Governorate).

3.5.3. Sampling Design

For selection of interviewees, the study area was divided into two blocks one is Jericho city area and the second block is the surrounding localities in the Jordan Valley area (Jericho Governorate). The number of interviewees was decided for 2% - 3% of the target group in the study area, Figure (1) below shows the distribution of survey samples.

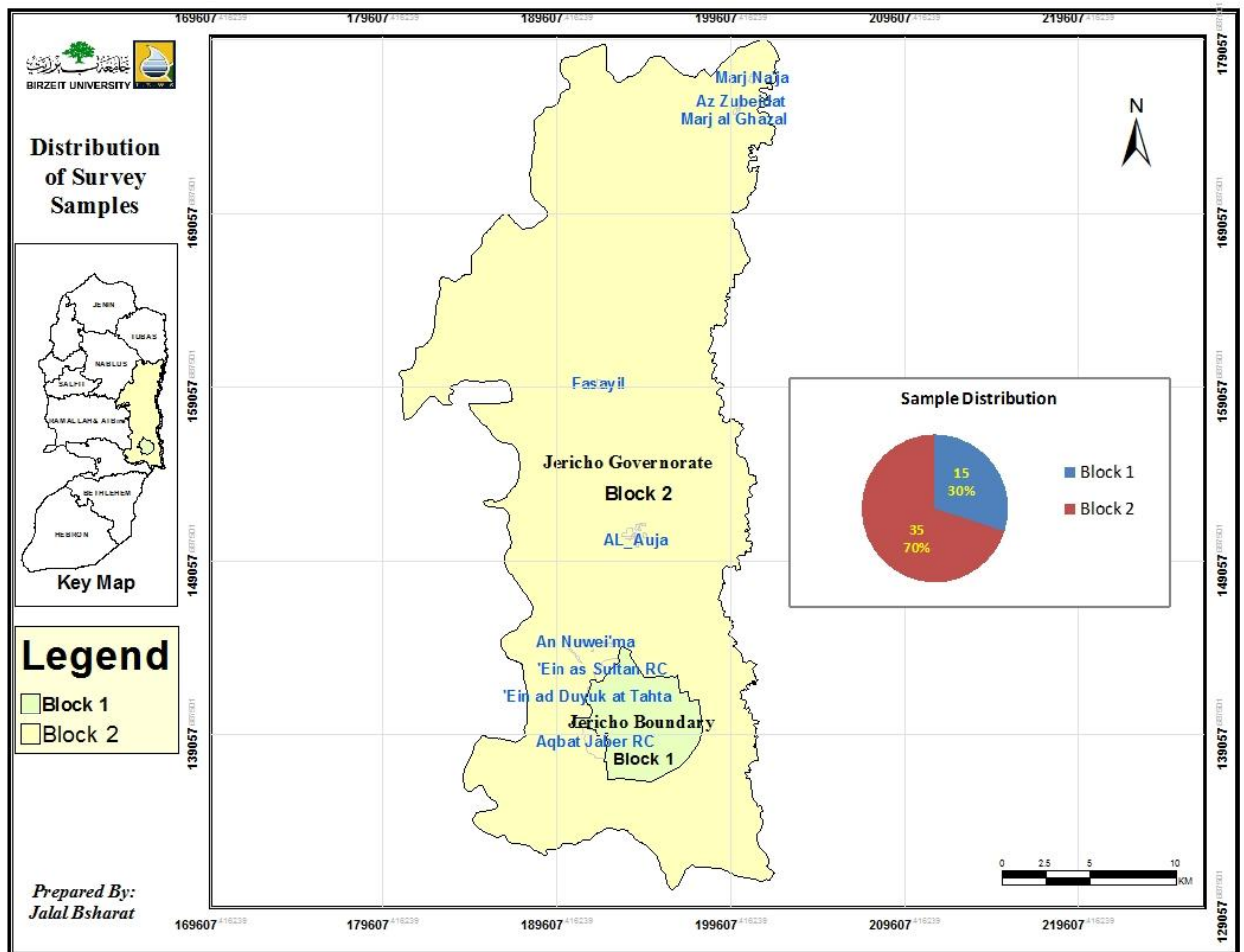

Figure 3: Distribution of survey samples in the study area

3.5.4. Questionnaire:

The questionnaire was written in English to be annexed to the final thesis report and then it was translated to Arabic to suit the level of respondents.

3.5.5. Interview:

The interview was carried out by contacting the target persons directly, respondents were visited at their locations and the questions were read out according to the questionnaire, then the answers of respondents were written down, whereas, some respondents were able to answer the questionnaire themselves and only few samples were sent and collected via emails, particularly the interviews with farmers' associations.

3.5.6. Questionnaire Analysis:

- **General Information (Gender, Age, Education and Career distribution of respondents)**

Table 28 (**Annex 5**) shows that 48 respondents were males and only 2 respondents were females, this is normal due to the nature of the Palestinian community and the social constraints for interviewing the females especially in the Palestinian rural areas. The respondent's age varies between 18 to above 51 years while the majority of the respondents were farmers with education below the Secondary level.

- **Water Supply**

Table 29 (Annex 5) shows that the largest percentage of respondents (76%) supplied through Agricultural wells while the rest (24%) are supplied from springs and other sources. However 64% of respondents answered “Sometimes” to the question if they are satisfied with the water supply.

- **Water cost and Land availability**

As shown in Table 30 (Annex 5), the annual water cost according to the respondents varies between less than 5000 up to 30000 NIS, however 70 % are paying between 5000 to 30000 NIS per year. The water consumption for agricultural purposes varied between 10000 to above 80000 CM/Y whereas 48% of the respondents consume between 21000 to 40000 CMY. Table 3 also shows that 54 % of respondents currently deduct between 10 – 20 % from their total income to cover the cost of Agricultural water whereas 12% deduct more. 74 % of respondents are managing up to 4 ha of agricultural lands and 90 % of respondents have potential land for future development up to 6 ha.

3. 6. Obstacles and constraints

As in any study, the survey entailed a number of obstacles that challenged the progress of the work. The researcher did his best to overcome these obstacles by thoroughly explaining the questions to the stockholders interviewed and crosschecking some of the information provided by asking questions in different manners and by direct observation, the most common obstacles were:

- Limited knowledge about desalination and effluent reuse methods: Many of the farmers encountered throughout the survey had limited knowledge about desalination and wastewater treatment issues, consumption, pricing and other water related information.
- Reduced responsiveness by some people, some farmers were not willing to fully cooperate with the survey and giving information about their agricultural water practices which was problematic.
- Social constraints: The nature of the Palestinian society may be perceived as being somewhat conservative and/or traditional depending on the area and community. In this case, some areas, and thus the researcher couldn't involve so many women in the research.

3. 7. Data analysis

Before beginning the actual data collection from the field, a pilot batch of 10 questionnaires was filled out after which the questionnaire was reviewed and modified based on the comments from the field.

A total of 50 farmers, agricultural associations, and water experts were surveyed. The data was entered into pre-designed spreadsheets after which it was validated by crosschecking 10% of the questionnaires. The data was analyzed later using the Statistical Package for Social Sciences (SPSS).

Chapter 4

4.1. Baseline Data – Assessment of water quantity in the area of study

According to the JICA regional development in the Jordan Rift Valley area (JICA, 2006) there are 19 springs originating from the eastern aquifer and discharge to the eastern slope of the Valley. Total discharge is estimated to be about 42 MCM/Y. The spring water resources are generally located far from the demand areas. There are leakage, seepage and evaporation losses estimated to be about 30% of spring water or 15 MCM/Y.

The Palestinian right of extraction of groundwater from the eastern aquifer is 54 MCM/year, and 78 MCM/Y for further development. The current groundwater extraction from the existing wells is estimated to be about 10-11 MCM/Y. Accordingly, the currently available water resources in Jericho and the Jordan Rift Valley area are assumed as summarized in the following table:

Table 4: Available Water from Eastern Aquifer in Jordan Rift Valley (JICA, 2006)

Water Resources	Springs (MCM/Y)	Wells (MCM/Y)	Total (MCM/Y)
Annual Available Volume	27	10	37

PWA and JICA regional development study estimated that there is a potential of 28 MCM/Y that can be added to the available water resources in the Jordan Rift Valley, This can be available in the short and medium term. They are: (i) Floodwater in Wadi Basins in the Jordan Rift Valley, (ii) Recycled water from wastewater treatments plants in major cities/towns, and (iii) brackish water on the lower terrace of the Jordan Rift Valley, accordingly, 15 MCM of recycled waste water can come from major cities on the central highland in the West Bank, such as Nablus, Ramallah, and East Jerusalem which flows down to the Jordan River basin.(PWA and JICA, 2005),It is expected that about 15 MCM/Y of recycled water might be made available for irrigation.

Table 5: Water Demand for the Jordan Valley Area to the year 2015

	Demand MCM/Y	Available MCM/Y	Potential for Development MCM/Y	Deficit
Municipal and Industrial	7.8	27 ²	-	+19.2
Agricultural Water Demand	81 ³	10 ²	15 (recycled Water)+ 28 Flood Water ⁴	-28
TOTAL	88.8	37	43	-8.8

Table 6: Production of Agricultural wells in the Jordan Valley 2009, source: (MoA and PWA, 2010)

No.	Area	Total number of wells	Working wells	Production / 2009
1	Jericho	93	28	1.7
2	DeirHijleh	2	0	0
3	Auja	9	7	0.43
4	Frosh BeitDajan	8	4	0.14
5	WadiFar'a	18	16	4
6	Fasael	1	1	0.06
7	Jeftlik	27	23	2.8
8	Zbeidat	3	2	0.35
9	Marj Na3jeh	13	7	0.8
10	Bardala	8	1	0.09
	TOTAL	182	89	10.37

² Total abstraction from wells and springs (PWA and MoA,2010)

³ Based on PWA and MoA plan to develop the water resources in the Jordan Valley (PWA and MoA, 2010)

⁴ JICA study team the Regional Development study for the Jordan Rift Valley (JICA study, 2006)

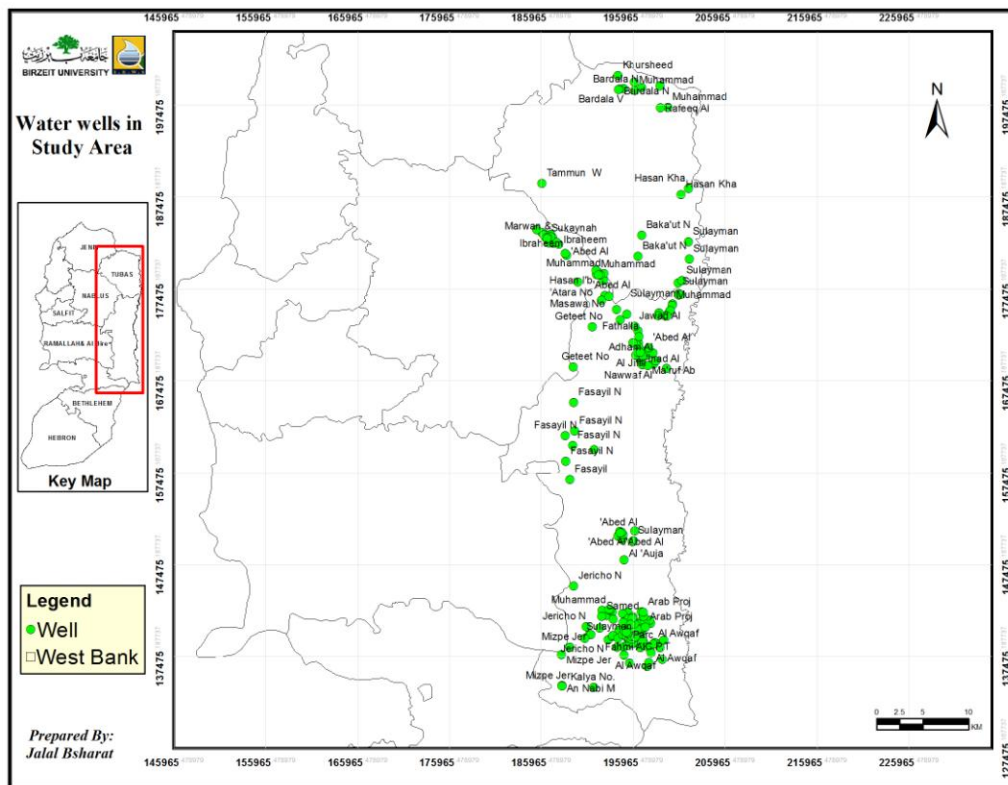

Figure 4: Ground Water Wells the Jordan Valley (PWA, 2013b).Desalination in Palestine.

The gap between the supply of freshwater and the demand for water for industrial, agricultural, and domestic use is growing at an alarming rate in Palestine. At the same time, the cost of desalination has come down steadily. Desalination is becoming more affordable and more people can benefit from an almost unlimited resource – seawater in Gaza strip and the good potential of brackish water in the Jordan valley.

According to the PWA annual report for the year 2011, desalination of brackish water is an optimistic option which is still not fully adopted in the West Bank whereas, it has been implemented on a small scale only as an approximate 2-3 MCM/Y of drinking ware, This amount of water is provided through the small scale desalination units that belong to 100 private water vendors in addition to one public sea water desalination plant and around six pubic brackish water desalination plants operated by CMWU and Municipal Departments (PWA, 2011).

The PWA recently finalized a study for water supply. Sea water desalination plant to be constructed in Gaza Strip with a total capacity of 13 MCM/Y, in the long-terms regional seawater desalination plant which will be constructed with a capacity of 55 MCM/Y by the year 2017-2022 (PWA, 2011).

In Palestine, the experience with desalination is new. Deir El Balah in Gaza Strip witnessed constructing the first RO –plant. Municipal water becomes a real problem for the people in Gaza. Therefore, they have started to install RO domestic units to solve their problem. According to policy, the PWA decided to increase the non-conventional water resources through adoption of desalination options (Ismail, 2003).

Water desalination by the technique of reverse osmosis consumes nearly around half of the energy needed for thermal processes. That’s why it has proved to be the lowest energy consuming technique according to many studies (Al-Karaghoul A, 2011).

There are some advantages like the modularity of RO units, the simplicity of operation, the compact sizes and lower environmental impacts that make RO units a better choice for water desalination in remote areas. Water desalination by RO units removes inorganic ions, organic materials, viruses and bacteria.(El-Ghonemy, 2013).

Table 7:Palestinian Standards for acceptable level of drinkable water (PWA, 2011).

No.	Parameter	Unit	Value
1	pH		6.5-8.5
2	Turbidity	NTU	5
3	Carbonate (CO ₃ ²⁻)	mg/l	ND
4	Bicarbonate (HCO ₃ ⁻)	mg/l	ND
5	Total Dissolved Solids (TDS) at 180° C	mg/l	1000
6	Sulphate	mg/l	200
7	Ammonium	mg/l	ND
8	Chloride (Cl)	mg/l	250
9	Nitrate (NO ₃)	mg/l	50
10	Calcium (Ca)	mg/l	100
11	Magnesium (Mg)	mg/l	100
12	Iron (Fe)	mg/l	0.03

13	Manganese (Mn)	mg/l	0.01
14	Sodium (Na)	mg/l	200
15	Potassium (K)	mg/l	10
16	Total Suspended Solids (TSS) at 105° C	mg/l	ND

4.2.1. Desalination in the West Bank

The increasing levels of salinity in groundwater are a significant sign of water degradation. The alluvial Pleistocene wells in the Jericho area, show high salinity, as well as high susceptibility to contamination (Khayat et al., 2006).

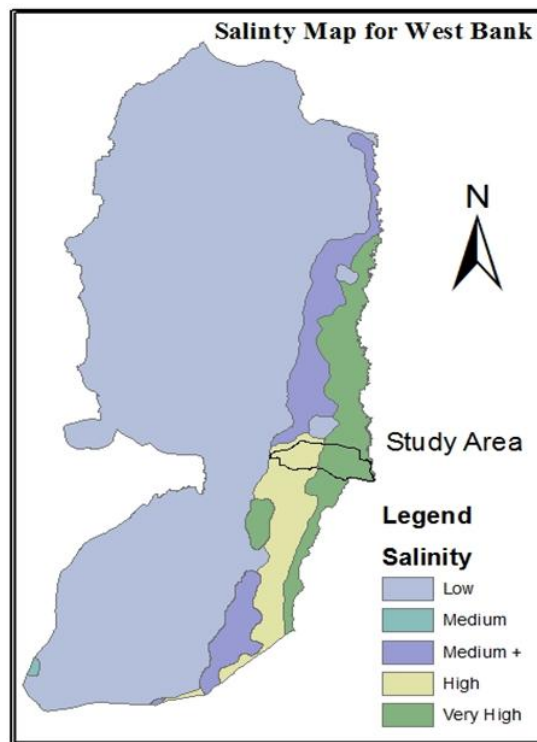

Figure 5: Salinity map for West Bank (PWA, 2012)

The growing demand for both domestic and agricultural use of water in the Jordan valley implies applying a reliable management for all available resources. Water scarcity implies seeking of new unconventional resources and making use of new efficient technologies.

There are several trends for the importance of desalination to provide future answers for water needs in the MENA region and it can be considered as a promising solution. Unfortunately and contrary to the situation in Gaza Strip, desalination, as a means of water purification, is not widely known in the West Bank. This referred to the fact that the majority of Palestinian communities in the West Bank are relying mainly on mountains aquifers with acceptable water quality.

Other areas in the West Bank are served through the Israeli water company (Mekorot) which controls most of the water resources in Palestine including the brackish water reserve in the Jordan Valley.

In this context, there were several attempts initiated by different actors involved in the water sector to implement new initiatives for water desalination. Most of desalination attempts were based on the RO technology, however, all these attempts were considered as pilot projects for limited extend or for scientific research and experimental purposes.

One of the objectives for this research is to collect general information on these actions and also to provide an initial assessment on their status.

4.2.2. Desalinating Plants in the Jordan Valley

A field survey has been conducted to evaluate the existing desalinated projects in the Jordan valley area; it is found that there are only four small scale R.O units located as shown in Figure 6:

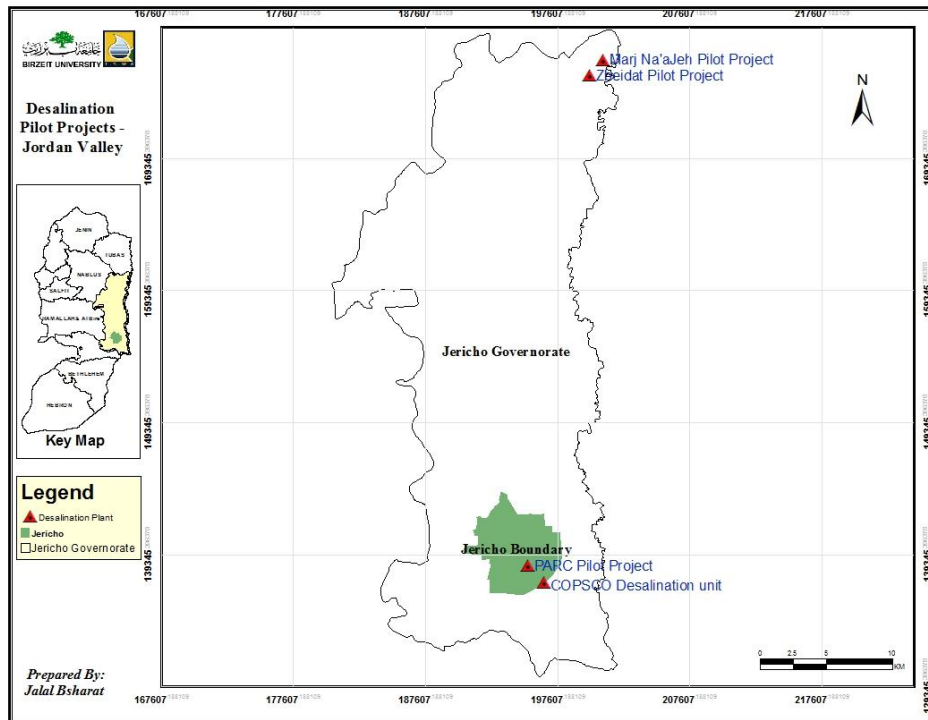

Figure 6: Location map for Desalinating projects in the Jordan Valley modified according to (Jericho-Municipality, 2013).

4.2.3. Desalination pilot project in Zbeidat village for domestic consumption



Figure 7: Zbeidt Pilot Project

As shown in Fig.7, the R.O. unit located in Zbeidat village 35 km north to Jericho city, has been implemented by Al-Najah University in cooperation with local contractor (Global Environment Services - GES) under the supervision of PWA. This project was donated by MEDRC (Shaieb, 2013), Table 8 below shows the quality

analysis for the source of water in Zbeidat RO unit .Annex(2), describes the technical data for Zbeidat plan

Table 8: Quality Parameter's for Feed water (AL-Najah, 2012).

Quality Parameter	Unit	Water Source (Well)	
		Zbaidat Well	Zbaidat Tank
TDS	mg/l	2681	2636
TSS	mg/l	9	10
pH		7.78	7.58
Chloride	mg/l	1200	1200
Sodium	mg/l	473	483
Sulfate	mg/l	166	157
Magnesium	mg/l	158	146
Calcium	mg/l	220	200
Potassium	mg/l	15.5	13.1
Iron	mg/l	0	0
Bicarbonate	mg/l	305	305
Bromide	mg/l	12.4	9.8
Silica	mg/l	26.6	21.6
Boron	mg/l	0.53	0.46
Nitrate	mg/l	37.6	36
Hardness	mg/l as CaCO ₃	1199	1098
SAR		4.04	6.34
Turbidity	NTU	1.2	1.0
Sediments after week		None	None

Table 9: Quality Parameters for Permeate and concentrate 2011, Source: (Al-Najah University, 2013)

Elements	Concentration (mg/l)		
	Feed	Permeate	concentrate
Li	0.10	0.00	0.20
Be	0.00	0.00	0.00
B	0.85	0.35	0.50
C	513.45	1.40	431.40
Na	425.90	6.44	776.00
Mg	128.60	0.00	304.55
Al	0.25	0.00	0.00
Si	12.50	0.00	0.00
P	0.65	0.00	1.90
Cl	1462.85	20.90	3403.55
K	30.90	0.38	47.85
Ca	146.50	0.00	200.30
Sc	0.05	0.00	0.00
Ti	0.15	0.00	0.00
V	0.00	0.00	0.05
Cr	0.10	0.00	0.05
Mn	0.00	0.00	0.00
Fe	5.15	0.00	0.00
Co	0.00	0.00	0.00
Ni	0.05	0.00	0.05
Cu	0.10	0.00	0.05
Zn	26.95	0.00	0.40
As	0.00	0.00	0.00
Se	0.00	0.00	0.00
Br	0.00	0.24	12.55
Pb	0.00	0.00	0.00
Cd	0.00	0.00	0.00
Sn	0.00	0.00	0.00
Ba	0.00	0.00	3.20

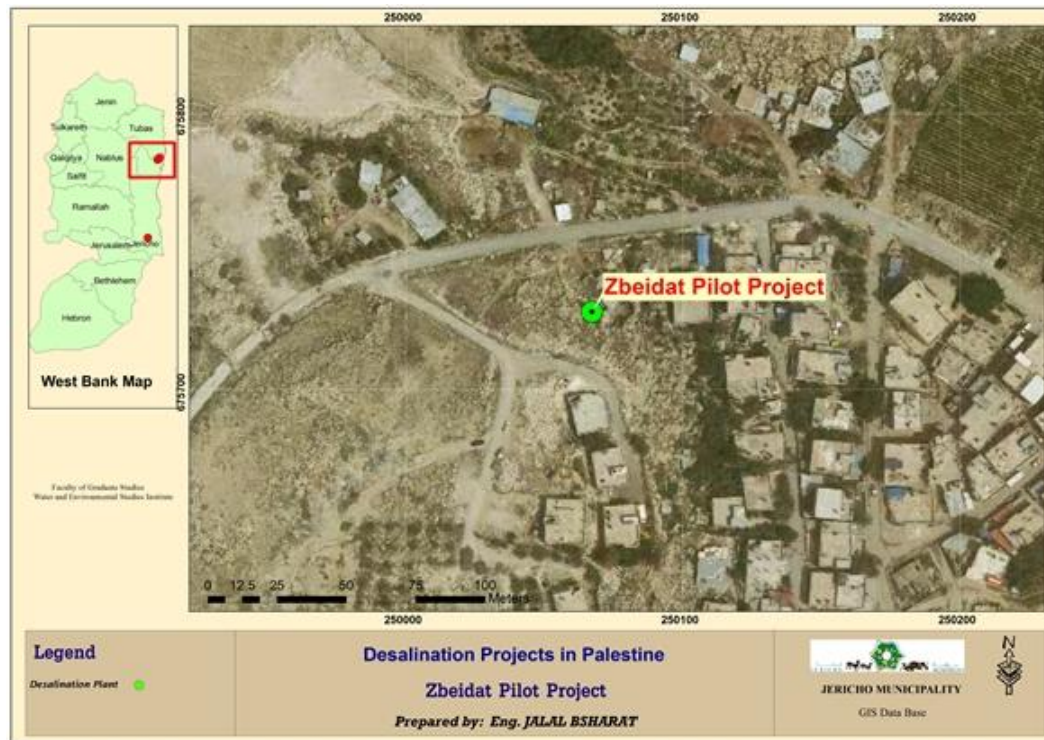

Figure 8: Location of Zbeidat Pilot Project

The desalination unit in Zbeidat is a typical R.O unit with special properties; this unit is totally supplied by a PV power plant.

- Intakes are the structures used to extract source water and transfer it to the process system.
- Pretreatment is removal of suspended solids and control of biological growth, to prepare the source water for further processing.
- Desalination is the process that removes dissolved solids, primarily salts and other inorganic constituents from the water source.
- Post-treatment is the addition of chemicals to the product water to prevent corrosion of downstream infrastructure piping.
- Concentrate management is the handling and disposal or reuse of waste residuals from the desalination system (El-Ghonemy, 2013)

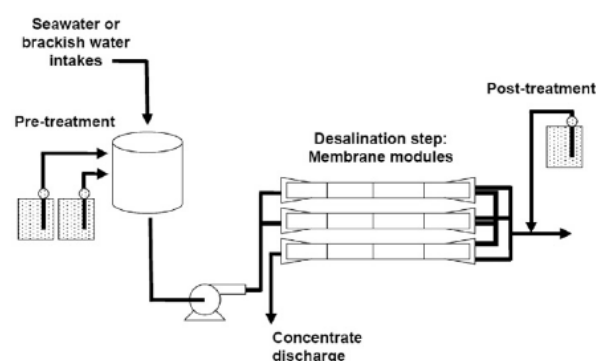

Figure 9: Simple Reverse Osmosis System (El-Ghonemy, 2013).

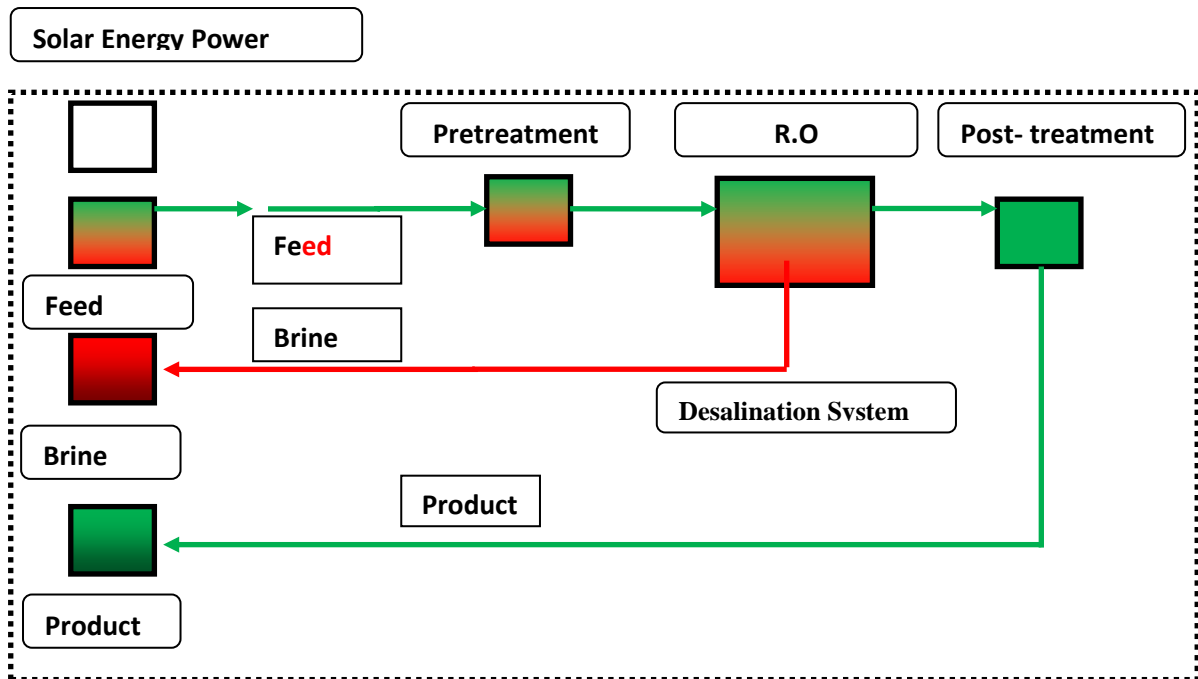

Figure 10: Typical schematic diagram of R.O Desalination System(ADAN, 2011).

Pre-Treatment Unit:

Pretreatment of feed water to the desalination plant is always required to insure trouble – free, reliable operation. The extent, number variety, and size of process unit in the pretreatment depend on the feed water quality and source (open intake, well water, and surface water).

For membrane processes, the major concerns based on (ADAN, 2011) are:

- Suspended solids plugging
- Scaling by metal oxides (FeOH₃, MnOH₃)
- Scaling by mineral salts (CaCO₃, CaSO₄, BrSO₄, SeSO₄, CaF₂, SiO₂)
- Fouling by mineral oil or other organic materials
- Biological fouling
- Membrane degradation by oxidation or other means.

Table 10: Expected pollutants and their possible treatment processes(ADAN, 2011)

Pollutants	Possible Treatment Processes
Suspended Solids (SS)	Sedimentation, Dissolve Air Flotation (DAF) Granular Media Filters (GMF), Ultra Filtration (UF), Micronics Filters
Colloidal matter	Coagulation and flocculation
Scaling	Scale inhibitors, PH adjustments, softening
Metal Oxides	Pre oxidization and SS Removal
Microbial growth	Pre chlorination, biocides
Dissolve organic matter	Coagulation and flocculation, activated carbon
Oxidizers	Reducing agent

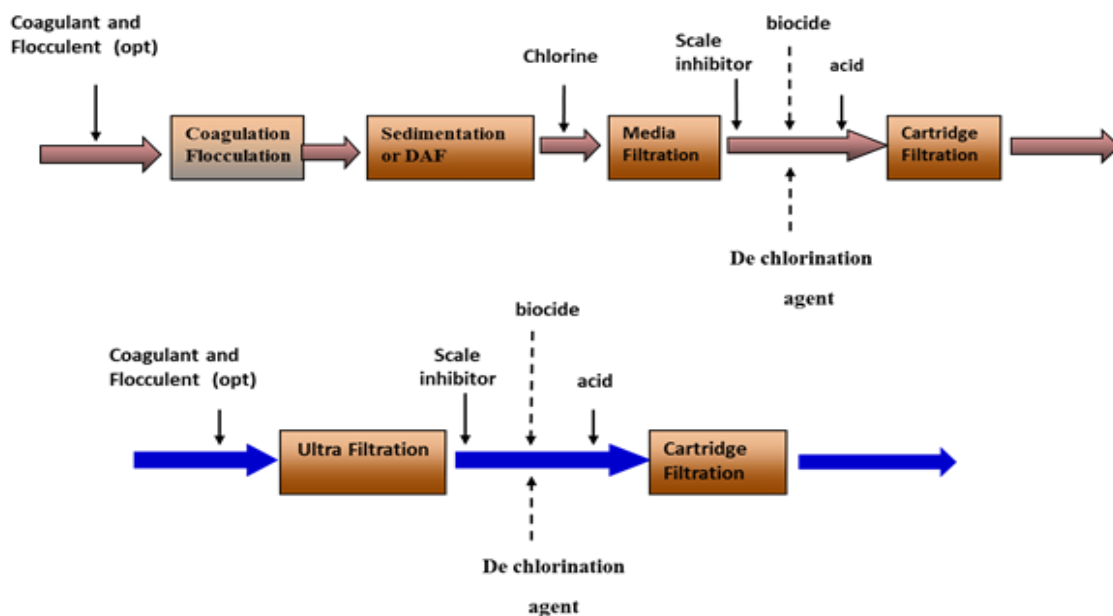

Figure 11: Typical pretreatment possible schemes, Source: (ADAN, 2011).

The Pre - filtration process in Zbeidat unit consists of two stages, the Media filtration and the Cartridge filters.



Figure 12: Pre-filtration unit in Zbeidat desalination plant

R.O unit:

The R.O unit in Zbeidat desalination plant is a two-stage process. The unit consists of three membranes of 4 inch diameter each (two membranes for the first stage and one membrane for the second stage).



Figure 13: R.O unit in Zbeidat desalination plant

Anti-Scaling Unit:

It has been stated by (ADAN, 2011) that without any means of upstream scale inhibition, RO membranes and their flow passages will foul due to scale, the precipitation of sparingly soluble salts. Common examples of scale are calcium carbonate (CaCO_3), calcium sulfate (CaSO_4), barium sulfate (BaSO_4), and strontium sulfate (SrSO_4). Less common but equally problematic are silica (SiO_2) and calcium fluoride (CaF_2) scales. The anti-scaling unit in Zbeidat desalination Plant consists of

100 liter anti-scalant tank with auxiliary dosing pump injecting the anti-scalant directly to the feeding water pipe.



Figure 14: Anti-scalant unit in Zbeidat desalination plant

Power Supply:

The R.O unit in Zbeidat is supplied through a PV power system of 28 solar modules providing an average 5 kw/hr. The main components of the PV system are:

- **Invertors:** Convert DC power from solar array to AC for use at electrical appliances
- **Cables:** Connect the system component
- **Storage:** Used to store solar – produced electricity for nighttime or emergency use
- **PV Panels:** Collecting solar radiation
- **Controller for battery charging:** Prevents batteries from being over charged
- **Power Switch and Fuse:** Allows power from a PV system to be turned off
- **Mattering:** Measures electrical production and use



Figure 15: PV energy supply system in Zbeidat desalination plant

Produced Water

The desalinated water produced by this unit is used for domestic consumption by nearby houses in the village. It has been estimated that between 6–8 CM of desalinated water are produced every day. The water is blended with saline raw water at (2:1) ratio in order to be normalized and maximize the benefit of this water; the raw water supply for this unit is produced from a local ground well in the area.



Figure 16: Product use in Zbeidat desalination plant

Brine disposal:

The concentrated water (Brine) is discharged to the Agricultural network; however, small scale pilot of salt drying beds has been tested in the site.

4.2.4. Marj Na'jeh desalinating pilot project for agricultural use

The Pilot R.O unit in Marg Na'jeh has been implemented by MoA through a joint fund from the Arab organization for agricultural development and the united nation development pregame (UNDP/ PAPP).

The purpose of this unit is to treat the high salinity brackish water produced from neighboring ground wells to be used for agricultural irrigation, the estimated production of the unit is around 400 cubic meters / day used to irrigate around 30 hectares of agricultural lands planted with vegetables and Legumes.

The total cost of this plant was \$150 000 (USD) with an average cost of \$ 0.15 (USD) per single cubic meter for operation and maintenance.

The plant is supplied with saline water from a neighboring ground well in the area and the total capacity of the plant is 75 cubic meters / hr with 73 % treatment efficiency, i.e. 20 cubic from the total are rejected as Concentrate and disposed to the Jordan river(Abuelhaija, 2013).

Table 11: Raw water analysis for the influent in Marj Na'jeh desalination pilot project, (Abuelhaija, 2013).

No.	Parameter	Unit	Value
1	EC	ds/m	7.8
2	TDS	mg/l	5000
3	pH		7.2
4	Ca	mg/l	17.2
5	Mg	mg/l	33.8
6	Na	mg/l	181
7	K	mg/l	48
8	HCO ₃	mg/l	274
9	Cl	mg/l	1914
10	SO ₄	mg/l	598
11	NO ₃	mg/l	47

Location:

As shown in Fig.15, the plant is located near Marj Na'jeh village 36 km north to the Jericho city.

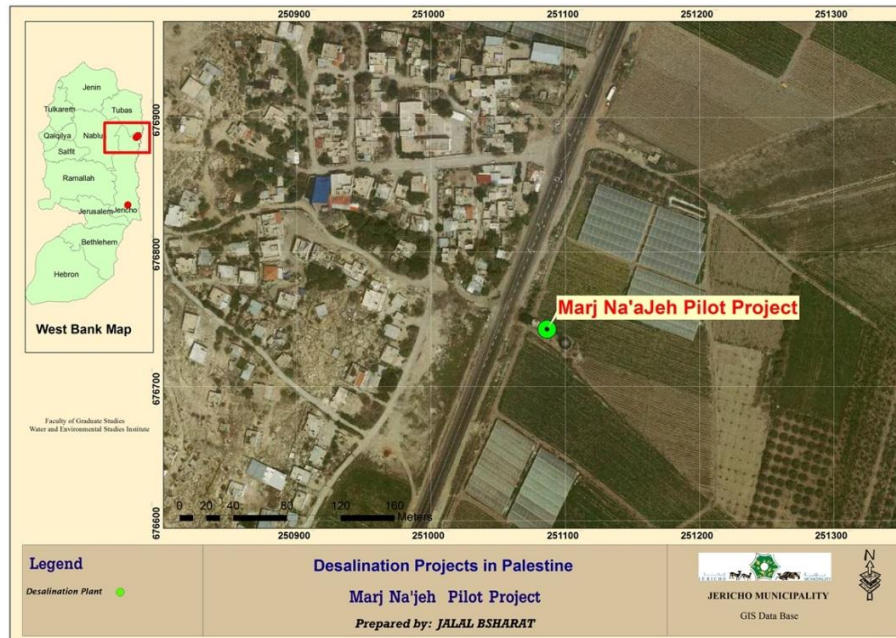

Figure 17: Location of Marj Na'jeh Pilot plan

Pre-filtration unit

The filtration process performed in two stages, sand filtration with automatic backwash and the cartridge filters.



Figure 18: Pre-filtration unit –Marj Na'jeh plant

R.O unit

The R.O unit in Zbeidat desalination plant is a single stage process. This process consists of 8 membranes each of 8 inches diameters (six membranes for the first stage and two membranes for the second stage).



Figure 19: R.O unit –Marj Na'jeh plant

4.2.5. PARC Desalination pilot project for agricultural use

PARC desalination unit is typical to the agricultural RO unit in Marj Na'jeh located 3 Km south east of Jericho city inside the premises of the Palestinian agricultural relief committees (PARC), this unit has been donated by GENERALITT VALENCIANA & FPSC and implemented by the PARC under the project of “Improvement in the management and accesses to water in the north of the Jordan Valley”.

The Project's main objective was to desalinate water produced from ground wells, which negatively affects the plants and soil.

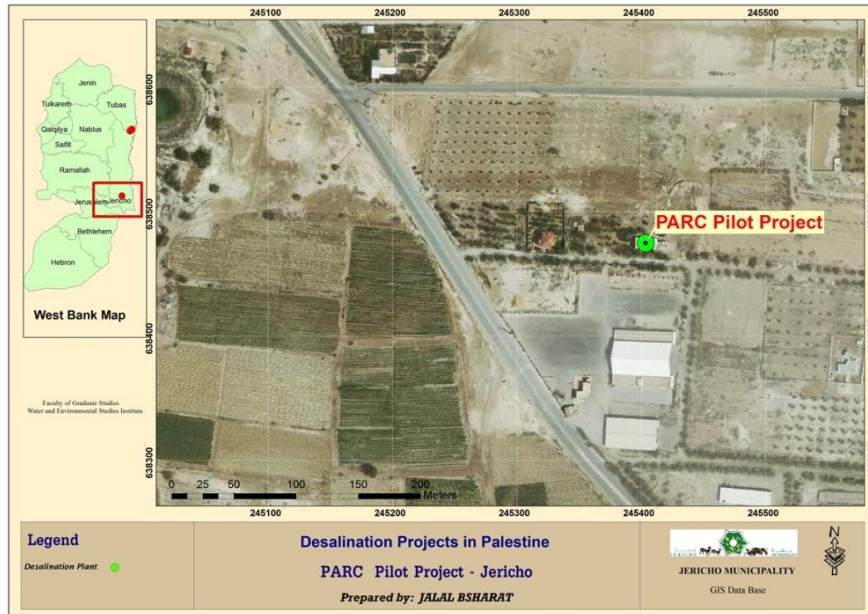

Figure 20: Location of PARC desalination pilot plant(Jericho-Municipality, 2013)



Figure 21: PARC R.O Unit

4.2.6. COPSICO desalination unit (Private sector)

As shown in Figure 24 below, the plant is located 5 Km S.E of Jericho and owned by The Private company; Consolidated Palestinian Company (COPSCO). This plant is used for desalinating high salinity water derived from private ground well inside the factory.

The plant has been designed and manufactured by the Turkish company “ARC SU ARTIMA TEKNOLOJILERI” and installed in the early 2013, the capacity of this

plant is 15-20 CM/D and the desalinated water produced by this plant is used for domestic, irrigation and also for industrial use.

The total cost of the RO plant is approximately \$ 40,000 (USD) and the operational cost has been estimated to 1.6 NIS per single cubic meter of desalinated water.(Huzaibi, 2013).

It is worth mentioning that the COPSCO desalination plant is the latest among all other desalination projects in the Jordan valley, this unit is even more advanced from technical point of view as the unit is fully automated in terms of control, backwash and membrane flushing. There are different chemical dosing units added for:

- Disinfection by Sodium hypo chloride
- pH adjustment acids
- Normalization of Sodium hypo chloride by SMBS
- Anti-scaling chemicals

The only criticism for this plant is the absence of a proper method for brine disposal. The brine is disposed to the nearest wadi and the fear that water might be infiltrated into ground causing degradation in soil and ground water. Table 12 shows the analysis for the Feed water in COPSCO desalination plant while Table 13 compares the water quality for Feed and Permeate.

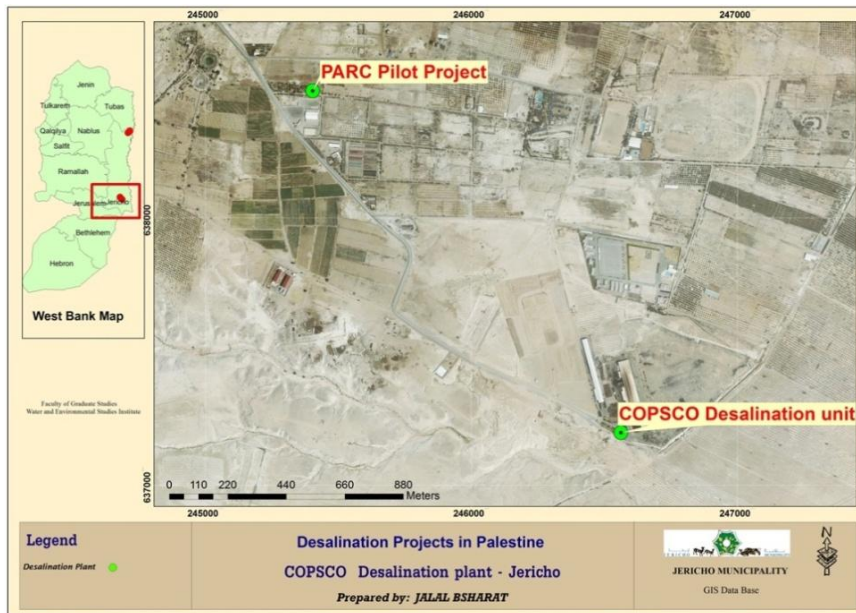

Figure 22: COPSCO Desalination plant –Jericho



Figure 23: R.O unit at COPSCO desalination plant

Table 12: Raw water analysis for the water source at COPSCO RO unit

No.	Parameter	Unit	Value
1	pH		7.8
2	Turbidity	NTU	1.9
3	Carbonate (CO_3^{2-})	mg/l	0
4	Bicarbonate (HCO_3^-)	mg/l	378
5	Total Dissolved Solids (TDS) at 180° C	mg/l	1918
6	Sulphate	mg/l	29
7	Ammonium	mg/l	0.04
8	Chloride (Cl)	mg/l	900
9	Nitrate (NO_3)	mg/l	22
10	Calcium (Ca)	mg/l	90
11	Magnesium (Mg)	mg/l	100
12	Iron (Fe)	mg/l	00
13	Manganese (Mn)	mg/l	0.00
14	Sodium (Na)	mg/l	398
15	Potassium (K)	mg/l	96
16	Total Suspended Solids (TSS) at 105° C	mg/l	20

Table 13: Comparison between Raw and Permeate water analysis

No.	Parameter	Unit	Raw water analysis	Permeate water analysis
CATIONS				
1	Calcium (Ca ⁺⁺)	mg/l	120	0.46
2	Magnesium (Mg ⁺⁺)	mg/l	162	0.63
3	Sodium (Na ⁺)	mg/l	1340	13.06
4	Potassium (K ⁺)	mg/l	156	1.60
5	Barium (Ba ⁺⁺)	mg/l	--	--
6	Strontium (Sr ⁺⁺)	mg/l	--	--
ANIONS				
7	Turbidity	NTU	1.9	--
8	Bicarbonate (HCO ₃ ⁻)	mg/l	488	62.64
9	Chloride (Cl)	mg/l	3000	3.43
10	Sulphate (SO ₄ ²⁻)	mg/l	200	0.77
11	Nitrate (NO ₃ ⁻)	mg/l	15	0.24
13	Fluoride (F ⁻)	mg/l	0	0
14	Carbonate (CO ₃ ²⁻)	mg/l	0	0
	Silica (SiO ₂)	mg/l	0	0
Other – little, Organic, etc.				
15	pH		7.2	6.5 – 7.2
16	Total Dissolved Solids (TDS) at 180° C	mg/l	5650	82.84
17	Conductivity	µs/cm	11000	131.2

4.2.7. Cost analysis assumption

The data and assumptions used for calculating the cost are summarized as follows:

- The pumping cost from wells is not included.
- No land cost has been considered.
- Capital cost is taken based on recent offer received supplying company \$ 40 000 (USD) against BWRO unit of 50 CM/D capacity(Huzaibi, 2013).
- Annual membrane replacement cost is estimated equal to 10% of the membrane purchase cost (El-Dessouky and Ettouney, 2002).

- Membrane purchase cost is estimated equal to 6% of the capital cost (El-Dessouky and Ettouney, 2002).
- The life time is assumed to be 10 years for the existing BWRO under the study.
- The others is actual data obtained from plants operation manual.

Table 14: Summary Data for Desalination Plants in the Jordan Valley

Unit	Use	Location	Owner	Treatment method	Treated water quantity CM/D	Capital Cost/\$USD	Finance	Date of est.	Power Source	Cost \$USD/CM	Brine Disposal
Zbeidat	Domestic	Zbeidat	PWA	RO	15	120,000	MEDRC	2012	On-site PV	0.083 ⁵	Mixing with Agricultural Water
MarjNa'jeh	Agricultural	MarjNa'jeh	MoA	RO	400 ⁶	150,000	AOAD & UNDP	2012	Electricity grid	0.166 ⁷	Discharged to Jordan River
PARC	Agricultural	Jericho	PARC	RO	400	150,000	GENERALITT VALENCIANA & FPSC	2012	Electricity grid	0.3	Drying pits
COPSCO	Domestic + Agricultural	Jericho	COPSCO	RO	50	40,000	Private Company	2013	Electricity grid	0.44 ⁷	Discharge to Wadi

⁵ As per calculated by in Zbeidat Pilot project.

⁶ As per calculated by. (Taha, 2014)

⁷ Source: (Huzaibi, 2013).

4.2. Existing Wastewater Treatment Plant in the Jordan Valley area

Currently, the Jordan Valley has no wastewater collection system instead cesspits are used. Wastewater that does not infiltrate to the groundwater is disposed of in a nearby sewage dump or simply into Wade's surrounding the area. A cesspit with an average volume of 25 cubic meters is usually emptied once every 5 to 6 months. Each tank load costs approximately \$ 20 (USD). Currently four sewage tankers are in use in the city alone. The dumpsite is located about 1.5 km east of the nearest residential area. This was the farthest point that could be reached due to the Israeli restriction on land use in the area.

Obviously, no treatment prior to disposal occurs. One existing private treatment plant belonging to Jericho's Casino was receiving small quantity of Jericho wastewater. Jericho Municipality used to discharge all wastewater coming from public facilities and other municipal centers into this medium scale plant. About 250 CM were dumped weekly. Some other small scale wastewater treatment units are available at Jericho hospital, Police academy, Jericho central jail and the residential guard training compound.

However, this is not the present situation. Wastewater quantity and characteristics are currently unknown due to the lack of data especially concerning Jericho. Usually the calculated wastewater generated is based on 70 - 80% of the water consumption, however the case in Jericho may be different due to the large amounts of water that are used in irrigation purposes for air conditioning, home gardens and yards.

4.3. 1. Jericho Wastewater Treatment Plant

In 2010 the PWA received a grant fund from the government of Japan through the international cooperation agency (JICA) to implement the project for the treatment and reuse of wastewater which will be collected by a sewage network expected in the near future.

The works started on the ground in August 2012 for both sewage network and the wastewater treatment plant which is expected to generate 2450 CM/D by the end of 2014 and the discharge will increase gradually until it reaches its maximum capacity of 9900 CM/D by 2025 , the treated effluent is suitable for agricultural use.

Within the framework of this project; one important component of the fund from the Japanese Government implemented through JICA; is the construction of a central WWTP. This WWTP will treat the domestic wastewater of Jericho City in addition to the industrial wastewater from Jericho Agro-industrial Park.

Sewage from both sources should be treated in one site at the eastern plains of Jericho within area (A). The WWTP is located in the middle of the ADS lands of Jericho Agro-Industrial Park (JAIP).

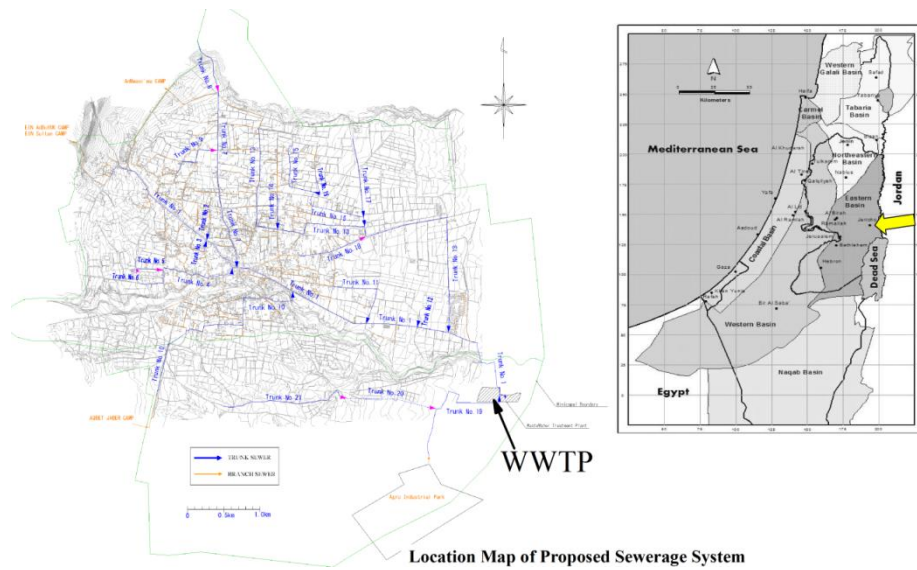

Figure 24: Location Map for JWWTP, Source: (NJS, 2013)

This project, the Jericho wastewater collection treatment and reuse project, aims at the construction of sewerage system in Jericho municipality where no similar system has ever been available. The project improves sanitary conditions and mitigates groundwater contamination which is incurred by wastewater penetration into the ground. The treated wastewater is aimed to be reused as valuable irrigation water. The WWTP is planned to be constructed at an agricultural land located south-east of Jericho Municipality, which has the lowest elevation in Jericho city. The land located in (A) Zone area within Palestinian dominion located next to C Zone, buffer zone to Israel and under Israeli dominion.



Figure 25: JWWTP under construction, 2013

Table 15: Design WWTP Capacity and Treated Wastewater Quality, Source: (NJS, 2013)

Items	Wastewater Amount and Quality			Effluent Quality
	Daily Average	Daily Maximum	Hourly Maximum	
Wastewater Amount (CM/D)	6,600	9,800	19,100	---
BOD(mg/l)	500			20
TSS(mg/l)	500			30
T-N(mg/l)	75			50

Table 16: JWWTP Design, Facilities & Concepts(NJS, 2013)

Facilities and Equipment	Contents
Receiving Tank for Vacuum Tanker Truck	To receive wastewater collected by vacuum tanker trucks and remove solid wastes and sand. It comprised screen channel and grit chamber.
Grit Chamber	It is composed of inlet channels, two screen channels and two trains (one for stand-by) of grit collector and a distribution chamber. Manual and auto screens are provided in the screen channel. Sand pumps and a sand separator are equipped with the slave of structure. The settled sand in the receiving tank for vacuum tanker truck is transmitted and also treated by this sand separator.
Reactor, Clarifier	Pollutants contained in wastewater are dissolved and removed. Two trains of the reactor tank with shape of OD tank have retention time exceeding 1 day of daily maximum wastewater amount. Two trains of the circular clarifier have surface load less than $12 \text{ m}^3/\text{m}^2/\text{day}$.
Chlorine Disinfection Tank	Equipped with the deforming pump, utility pump and weir-type flow meter. Sodium hypochlorite is applied for disinfection.
Gravity Sludge Thickener	The thickened sludge of surplus sludge is transferred to sludge drying beds.
Sludge Drying Bed	Dries thickened surplus sludge. Sludge depth is 30cm and hauled outside of beds after 14 days. Half of planned beds are to be constructed by this project.
Electrical Equipment	The power is received from Jerusalem District Electricity Company (JDECO). The major equipment can be operated by engine-driven generator and by a solar panel with capacity of 100 kW. Return surplus power to power grid. The operation supervision is carried out by monitoring screen connected to computer installed in administration building but basically the facilities shall be manually operated at site.

Table 17: Estimated Wastewater Quantity and Quality from JWWTP, Source (NJS, 2013)

Areas / Year		2010	2015	2020	2025	Ultimate
Jericho Municipality	Population (P)	25,895	28,792	32,042	35,692	35,800
	C. Population (P)	0	14,396	25,634	32,123	35,800
	C. Ratio (%)	0	50	80	90	100
	WW Volume (m ³ /d)	0	2,403	4,291	5,391	6,006
Surrounding Areas	Population (P)	14,088	17,263	20,722	24,466	24,600
	C. Population (P)	0	0	10,361	17,126	24,600
	C. Ratio (%)	0	0	50	70	100
	WW Volume (m ³ /d)	0	0	1,067	1,882	2,703
Agro-Industrial Park	Population (P)	0	0.23	100	100	100
	C. Population (P)	0	270	1,180	1,180	1,180
Total	Population (P)	39,983	46,055	52,764	60,158	60,400
	C. Population (P)	0	14,396	35,995	49,249	60,400
	WW Volume (m ³ /d)	0	2,673	6,538	8,453	9,889
Average Concentration	BOD	---	342	400	401	408
	TSS	---	392	452	456	466
	T-N	---	64	71	73	76

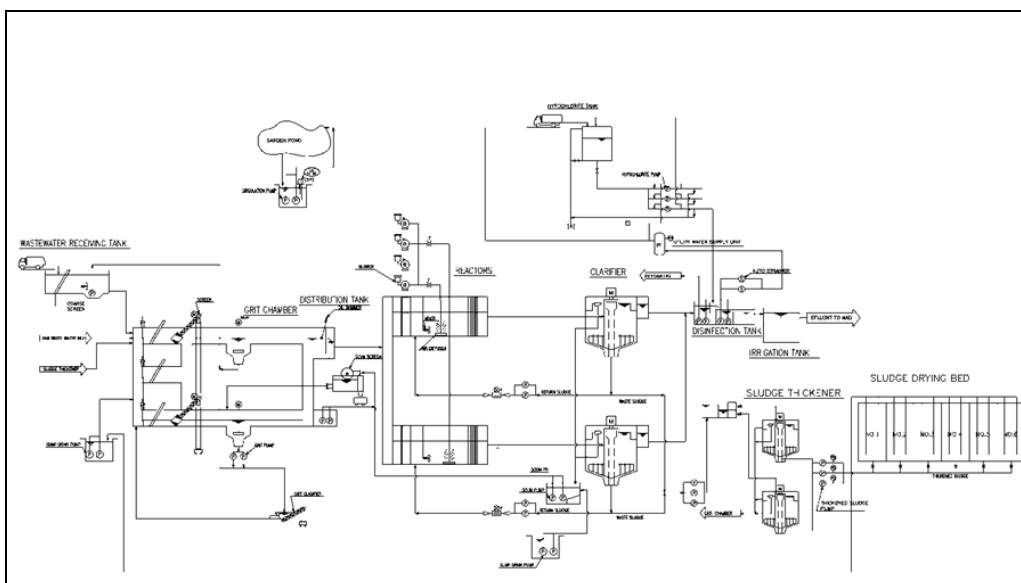

Figure 26 : JWWTP- Treatment Flow Sheet, Source: (NJS, 2013).

Table 18: Estimated annual cost and average cost for treated effluent in JWWTP, (NJS, 2013).

Items			2014	2015	2016	2017	2018	Sum	Remarks
O&M Cost	Personnel		262,782	473,013	496,644	521,483	547,554	2,301,476	
		Managers and	82,042	147,676	155,052	162,800	170,944	718,514	
		Technicians and Workers	180,740	325,337	341,592	358,683	376,610	1,582,962	
	Electricity		7,195	203,949	474,428	798,669	1,177,373	2,661,614	
		Fixed Charge	47	85	89	93	98	412	
		Metered	7,148	203,864	474,339	798,576	1,177,275	2,661,202	Solar Deducted
	Repair		0	299,603	665,817	1,406,212	401,790	2,773,422	
	Chemicals		7,323	31,825	58,897	91,134	128,706	317,885	
	Sum	A	277,300	1,008,390	1,695,786	2,817,498	2,255,423	8,054,397	
Capital Cost	Interest		0	0	0	0	0	0	
	Depreciation	0%	0	0	0	0	0	0	
	Sum	B	0	0	0	0	0	0	
O&M and Capital		c=a+b	277,300	1,008,390	1,695,786	2,817,498	2,255,423	8,054,397	
Annual			252,945	813,950	1,434,720	2,113,350	2,844,080	7,459,045	
Cost : \$USD /CM			0.3045	0.3441	0.3283	0.3703	0.2203	0.2999	Avg= 0.311

4.3. 2. Wastewater treatment plant in the Intercontinental hotel

The WWTP in the Intercontinental hotel with capacity of 800 CM/D is located in the southern entrance of Jericho. This WWTP serves mainly the hotel and the sewage brought to the site by the sewage tankers from Jericho, the type of treatment is SBR.

The WWTP at Intercontinental hotel is a private property established 1998 and operated by a technical team in the hotel.

The total cost of the WWTP is approximately \$ 1.6million (USD), the cost of one cubic meter of reclaimed water estimated to be approximately \$ 0.45 (USD) which appears high for the first while but can be justified that the WWTP is not operated at full capacity and also by considering the extra energy consumption required for post treatment.

The reclaimed water used for irrigating 50 ha of Palm trees , landscape trees and green yards surrounding the hotel area while the sludge is collected by seepage trucks and disposed at Jericho dumping site.



Figure 27: WWTP in Jericho Intercontinental Hotel

4.3. 3. Compact units in Jericho district

The small scale (modular units) in Jericho are located in Jericho hospital, Police academy, Residential guard compound and in the Jericho Central Jail, each unit has three chambers which are anoxic zone, extended aeration zone and sedimentation zone. Extended aeration process results in wide band operation regarding permitted concentrations of solids in the aeration tank (2500-5000 mg/l). The efficiency of the system is enhanced by the use of Free-floating Bio-film carrier media.

Each unit consists of aeration tank, settling tank and control room. Each modular unit has different size.

Table 19: Capacity and Design Basis(ARGES, 2013).

Capacity	150 CM/D
BOD	500 mg/l
TSS	553 mg/l
Total N	120 mg/l
Total P	13 mg/l
pH	6-9

Table 11: Effluent Water Characteristics, Source: (ARGES, 2013)

	Composite Sample	
	2 hours	24 hours
B.O.D.	50 mg/l	20 mg/l
TSS	70 mg/l	20 mg/l
Total N	50 mg/l	20 mg/l
Ph	6-9	6-9

Table 20: Total Power Consumption for Jericho Hospital WWTP (ARGES, 2013).

Equipment	Installed Power (kW)	Absorbed Power (kW)	Working Hours	Amount	Total Power
Inlet Pumps	1,10	0,88	24	1	21,12
Blowers	5,50	4,40	20	1	88,00
Sand Filter pumps	1,50	1,20	24	1	28,80
Chlorination Pumps	0,06	0,05	20	1	0,96
Effluent Irrigation Pumps	1,10	0,88	24	1	21,12
TOTAL (KW/day)					160,0

Table 21: Chemical and Electrical Consumption / Year Source: (ARGES, 2013).

Name	Quantity	Unit Price (EURO)	Monthly (EURO)	Yearly Price (EURO)	Yearly Price \$(USD) Rate 1:1.39
Drive Unit Gear Oil (L/year)	1	14	-	14	19.46
Chlorination (L/day)	18,75	0,5	281,25	3375	4.69125
Electrical Consumption	58.400	0,133	-	7767.2	10796.41
Sand (kg/year)	25	1		25	34.75
Cartridge Filters	8	6,6	52,8	634	881.26
TOTAL				11815.2	11736.57
Cost \$ (USD) /CM⁸					0.3



Figure 28: WWTP in Residential Guard compound



Figure 29: WWTP in Jericho Hospital

⁸ Annual discharge : 150 CMD*365=54750 CM/Y



Figure 30: WWTP in the Jericho Central Jail and Police Academy

Table22: Summary Data for WWTP's in the Jordan Valley: Summary Data for WWTP Plants in the Jordan Valley(ARGES, 2013).

Station	Location	Owner	Treatment method	Treated water quantity CM/D	Capital Cost/\$(USD)	Finance	Date of est.	Power Source	Cost \$USD/CM
Jericho WWTP	Jericho	Jericho Municipality	Extended Aeration	2450-9900	18,000,000	Government of JAPAN	2012	PV+ Electricity Grid Network	0.311
Intercontinental Hotel	Jericho	Intercontinental Hotel	Aerated Tanks	800	1.600,000	Private Investment	1998	Electricity Grid Network	0.4
Small scale Modular Units	Jericho	PNA	Extended Aeration	75	130,000	USAID and Canada	2012	Electricity Grid Network	0.3
WWTP at Jericho Hospital	Jericho	MoH	Extended Aeration	150	150,000	ANERA		Electricity Grid Network	0.3

4.3. Case study - Arab development society (ADS)

Arab development society was founded in 1945 to assure the welfare of Palestinian refugees after the British mandate withdrew from Palestine in 1948. The Palestinian nationalist “Mosa Alami” and Arab league economic committee were the biggest supporters of the association. Following the establishment, the ADS engaged project to explore for water by the support of United Nations relief agency (UNRWA). ADS started cultivation in the surrounding lands in order to accommodate, train and educate the Palestinian refugees (Hodgkin and Christian, 1953-1984).

New activities are added to the project; students were trained in vocational skills such as Electrical engineering, weaving, carpenter and metal work. The ADS was significantly damaged during the 1948 and 1967 but managed to recover by the help of Friend Organizations in the United Kingdom and USA (Hodgkin and Christian, 1953-1984).

4.6.1. Arab Development Wells

According to the ADS Chief board Dr. Mohammed Qotob,” before 1967, ADS operated 26 wells which have been drilled upon the establishment of the project in the mid-fifties. All wells have produced a good quality of water with acceptable salinity percentage and the surrounded land was cultivated with Citrus and Trees especially in the Northern area of the project lands. However, only small part of the Southern area has been planted because of the high salinity of the soil which reached up to 18000 (μs), which means that these areas were not fully cultivated as no trees or plants can survive or give a good yield when irrigated with this water,(Qotob, 2014).

(Qotob, 2014) has also pointed out that over extraction by Israeli wells in the Western area of Jericho has changed the geological map for the area. Israeli wells were drilled along the catchment and recharge area for the Alluvium shallow wells in Jericho, these wells were drilled to the west of Wadi Qelt and Wadi Nweimeh which are the main Wade’s responsible for recharging the Quaternary aquifer in Jericho, consequently, all wells located in the Northern area of the ADS have become totally dry or the water level declined dramatically to a sever level below the level of existing pumps. The average depth of ADS wells were ranging between 50 – 60 m while the water level now is below the 70 – 120 meters below the ground level.

On the other hand, rehabilitating and re-drilling was not efficient because of the small diameter of existing casing. Figure 30 below showing a map for well locations while Table 23 in (annex 6) shows the status and technical data of each well.

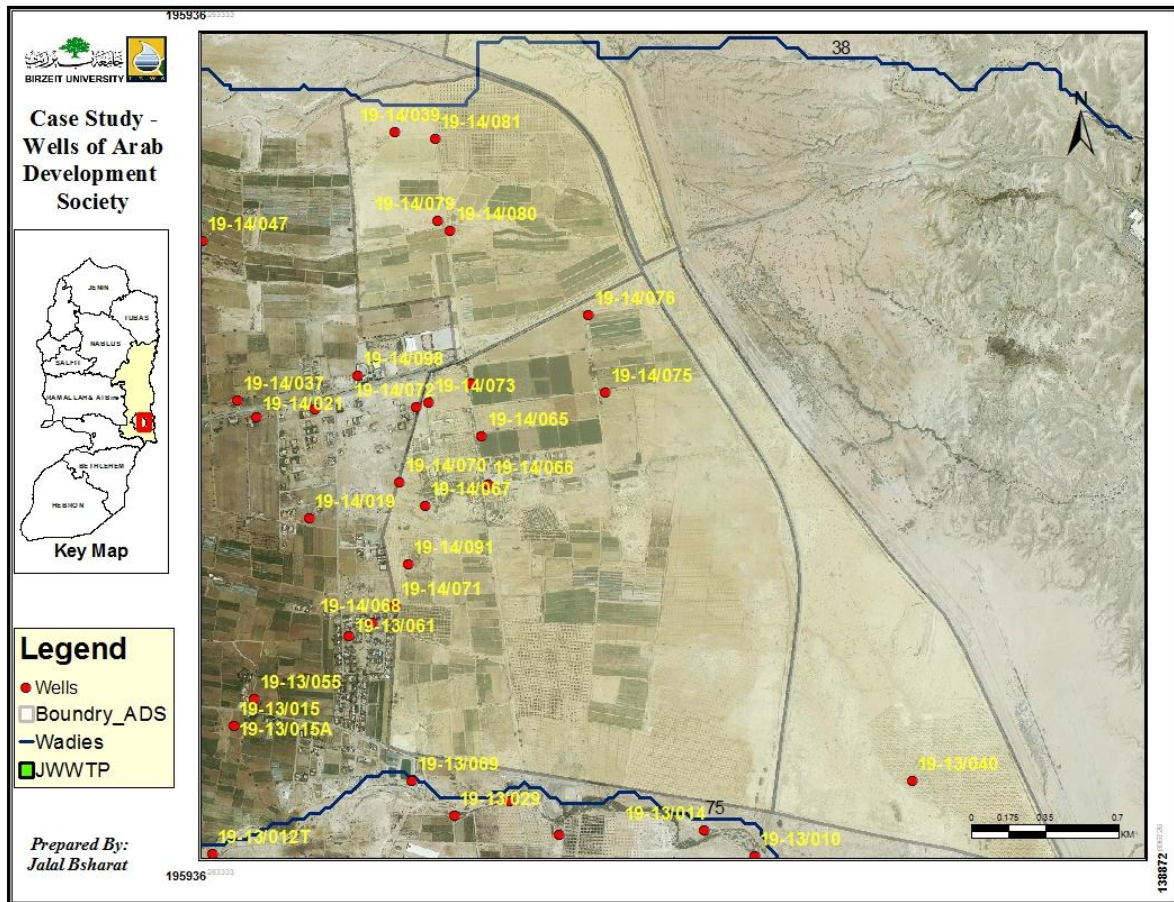

Figure 30: Map for ADS wells, edited according to (PWA, 2013).

The wells which are located in the southern area of the ADS have never been operated since 1967. It is found that the water quality is very bad and the salinity is very high up to 8000 (μs), also it has been concluded that it is more feasible to drill new wells rather than rehabilitating the existing wells because the existing casing is very old and often collapsed during the drilling.

It has been estimated that drilling and equipping of new shallow wells in Jericho area will cost at least \$ 162,000 (USD) (Bsharat, 2012).

From total 750 ha owned by the ADS, only 500 ha are permitted by the Israeli's and made available for cultivation and by giving the fact that each hectare will need minimum 10000 – 12000 CM/Y. A minimum 5 – 6 MCM/Y will be needed in order to meet the irrigation requirements for all available lands owned and accessed by ADS.

4.6.2. Water Shortage at Arab Development Society:

The main problems related to the water at Arab development society are:

- High salinity of some wells. TDS ranging from 2000 – 8000 ppm) making this water unsuitable for most of the crops except palm trees and animal

fodder which are tolerating water salinity up to 2000 ppm but giving less yield as much as the salinity increased .

- Lack of experience and financial capacity to apply feasible desalination methods or Effluent reuse schemes.
- The difficulty of operating the wells at maximum capacity due to the fact that wells are very old and rehabilitating them is not feasible because of insufficient diameter of the casing, in addition to the shallow depth of the well caused by the accumulation of sediments inside the well and corrosion of the casing.
- The dramatic drop of ground water level from 50 – 60 m to 70 – 120 m which caused the dryness of some wells especially in northern area of the ADS project.
- Some wells are located in area “C” and their permits are already expired since 1967 and the Israeli’s are not renewing the permissions neither giving a permission to rehabilitate or re-drill those wells.
- Lack of reliable and feasible studies of what can be done in minimum cost.

4.6.3. Potential for Development:

- Availability of permission for 26 wells gives the opportunity for renewing these permissions and operating these wells to increase the water production.
- The availability of promising water quantities of brackish water which can be desalinated to improve water resources.
- The availability of low salinity water produced by neighboring wells already supplying some farms inside the ADS, this water can be useful to blend with brackish water and reduce the salinity.
- The location of the ADS which lies between the two main Wadi’s in Jericho (Wadi Qilt and Wadi Nweimeh) with average annual discharge of 6 MCM/Y, this can be considered as an optimistic source of low salinity water that can be collected, stored and used for direct irrigation or blending with brackish water.
- The advantage for the ADS of being close to JWWTP which is located only 570 meter to the South East of ADS area.

Table 23: Land Use at ADS

Location	Area / ha
Historical lands owned by ADS	750
Lands under ADS control (Permitted by the Israeli's)	500
Area located beyond the road 90 (Under Israeli control)	250
Northern Project	200
Southern Project	30
Lands available for ADS use for time being and the potential for future	100
Lands rented by farmers	400

Table 24: Water requirements at ADS

Location	Area / ha	Water Requirements CM/ ha /Y	Total
Lands planted by Palm trees or will be planted in the future	400	12000 (120 trees /ha)	4,800,000
Total lands planted with vegetables	35	7000	245,000
Lands planted with Livestock Fodder	50	3000	150,000
Lands used for housing and public parks	15	10000	150,00
Total requirements for irrigating the total area	500		5,195,000

The total water quantities available for ADS based on the current data provided by ADS are: $117 \text{ CM/H} * 18 \text{ (Average Operation Hours)} = 854100 \text{ CM/Y}$, i.e., the shortage between supply and demand is still 4340900 CM/Y

4.6.4. Potential Water Resources

4.6.4.1. Treated effluent from JWWT

According to (NJS, 2013), JWWT will receive wastewater from Jericho city, Jericho Agro-Industrial Park and the surrounding localities (Dyouk , Nweimeh , Aqabat Jabir and Ein-sultan Refugee Camps. The expected quantities of treated Effluent will be as shown in Table 26 Which shows that by 2015, ADS can benefit from 2673 CM/D of treated effluent generated from JWWT if ADS managed to hold an agreement with Jericho

Municipality for utilizing this water, furthermore, the benefit can be optimized by blending the treated effluent with high salinity brackish water⁹, which means that in 2015, ADS will be able to increase its agricultural water resources by additional 117077410 CMY. According to (AbuSeb'a, 2014), Jericho Municipality has decided 0,3 NIS as a price for one cubic meter of treated effluent.

Table 25: Estimated quantities of treated effluent generated from JWWTP (NJS, 2013).

Areas / Year		2010	2015	2020	2025	Ultimate
Total	Population (P)	39,983	46,055	52,764	60,158	60,400
	WW Volume (CM/D)	0	2,673	6,538	8,453	9,889

According to the Palestinian standards for treated wastewater effluent for agricultural purposes, treated wastewater has been classified into four classification: High quality (A), Good quality (B), Medium quality (C) and Low quality (D). Table 27 below indicates the standard specifications for wastewater quality as per decided by PWA and the MoA (MoA and PWA, 2013).

Figure 31 shows a proposed piping system connecting ADS wells to a proposed mixing tank for the purpose of blending brackish water with treated effluent or harvested Wadi Run Off water.

⁹- 1 liter of Brackish water of TDS 5000 ml/l and blended 4 liters of treated effluent from JWWTP of TDS 400 ml/l, the TDS of the final product will be 1080 ml/l (5400 / 5).

¹⁰ - Expected daily discharge of treated effluent from JWWTP is 2673 CMD equal to 975645 CM/Y. This quantity can be increased by fifth when blended with brackish water in ADS.

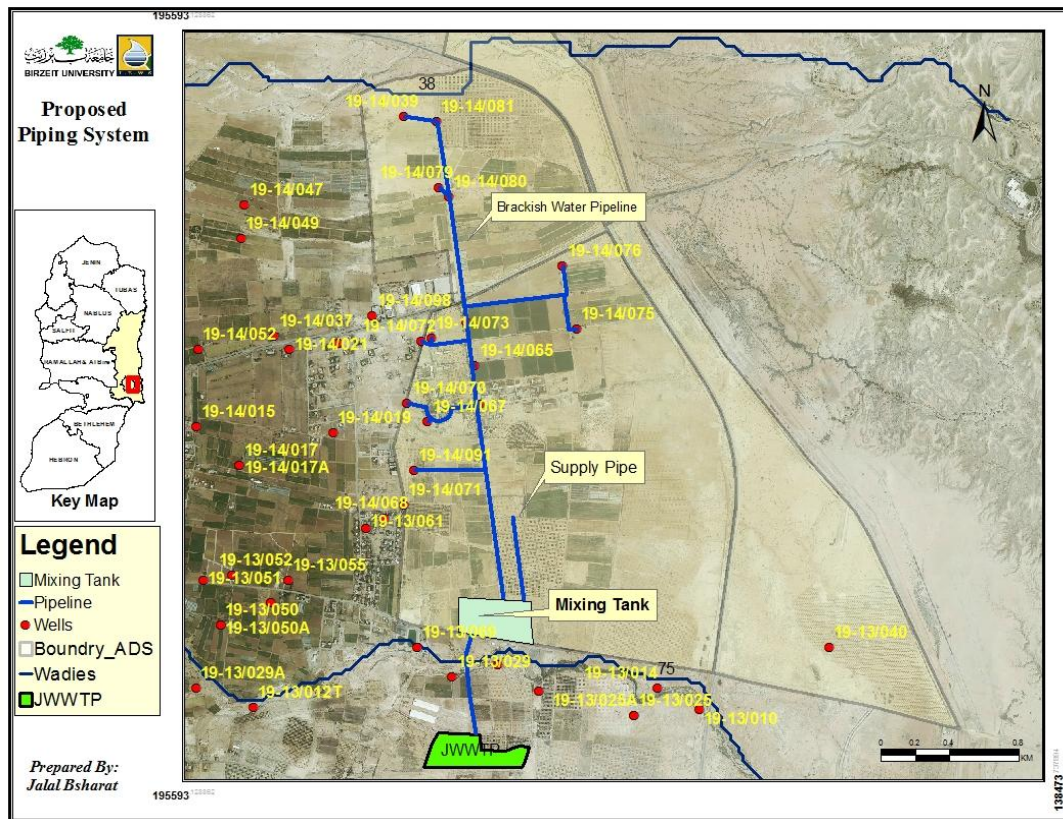

Figure 31: Proposed plan for reusing of treated effluent

Table 26: Wastewater quality standards (MoA & PWA, 2013)

Maximum Limits for chemical and biological properties (mg/l) unless otherwise stated	Quality of treated Wastewater			
	High quality (A)	Good quality (B)	Medium quality (C)	Low quality (D)
Water Oxygen uptake BOD5	20	20	40	60
Total suspended solids TSS	30	30	50	90
Fecal coliform bacteria (colony/100 ml)	200	1000	1000	1000
Chemically absorbed Oxygen COD	50	50	100	150
Dissolved Oxygen DO	Less than 1	Less than 1	Less than 1	Less than 1
Total dissolved solids TDS	1200	1500	1500	1000
Power of Hydrogen PH	9_6	9_6	9_6	9_6
Fat, Oil and Grease	5	5	5	5
Phenol	0.002	0.002	0.002	0.002
Detergents MBAS	15	15	15	25
Nitrate -Nitrogen No3_N	20	20	30	40
Ammonium _ Nitrogen NH4_N	5	5	10	15
Total nitrogen Total – N	30	30	45	60
Chloride Cl	400	400	400	400
Sulfate SO4	300	300	300	300
Sodium Na	200	200	200	200
Magnesium Mg	60	60	60	60
Calcium Ca	300	300	300	300
Sodium adsorption ratio SAR	5.83	5.83	5.83	5.83

Phosphate Phosphorus PO4_P	30	30	30	30
Aluminum Al	5	5	5	5
Arsenic As	0.1	0.1	0.1	0.1
Copper Cu	0.2	0.2	0.2	0.2
Fe	5	5	5	5
Manganese Mn	0.2	0.2	0.2	0.2
Nickel Ni	0.2	0.2	0.2	0.2
Lead Pb	0.2	0.2	0.2	0.2
Selenium Se	0.02	0.02	0.02	0.02
Cadmium Cd	0.01	0.01	0.01	0.01
Zinc Zn	2	2	2	2
Cyanide CN	0.05	0.05	0.05	0.05
Chrome Cr	0.1	0.1	0.1	0.1
Mercury Hg	0.001	0.001	0.001	0.001
Cobalt Co	0.05	0.05	0.05	0.05
Boron B	0.7	0.7	0.7	0.7
Bacteria E.coli (Colony /100 ml)	0010	0100	0100	0100
Nematodes (Eggs/L)	Less than or equal 1	Less than or equal 1	Less than or equal 1	Less than or equal 1

4.6.4.2. Run off harvesting and the possibility for artificial recharge and blending with brackish water

The scarce water situation in the Palestinian territories implies seeking of new water resources. Storm Water Harvesting (SWH) can be considered as a reliable management technique for collecting, storing and distributing the flash floodwater of the major wadi's during the winter seasons. This technique will increase water storage of groundwater aquifers and provide additional quantities of water for agricultural sector during the dry and high-water demand in the summer seasons.

Flashing and intense rainfall events over the western highlands of the Jordan Valley can lead to short term surface water availability, without a proper management of this significant water resource, the excess rainfall can be quickly lost due to the high evaporative environment and loss from the watershed via runoff without any proper benefit (PWA, 2012).

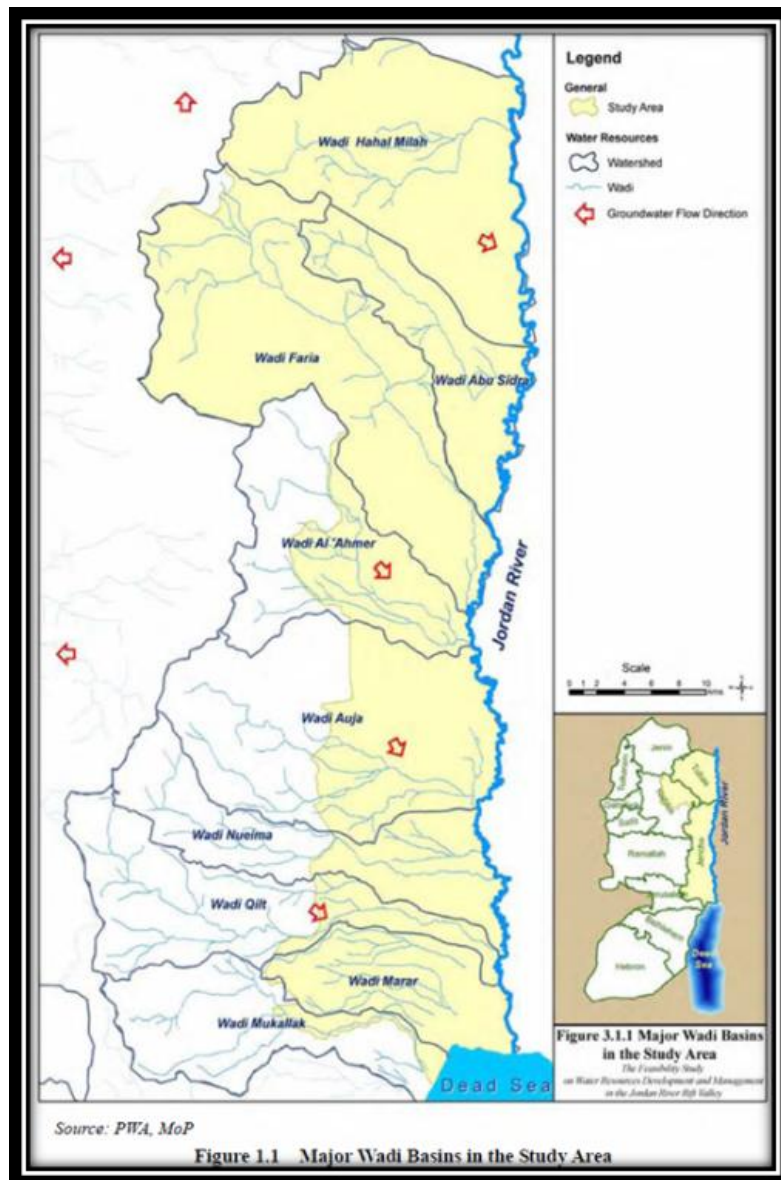

Figure 32: Major wadi basins in the study Area (PWA, 2013).

Therefore, this technique can be implemented in one of the major wade's in the Jordan Valley. Wadi El-Qilt and Wadi Newimeh are the most important wade's in Jericho area stretching from mountain region in the west and passing the middle part of Jericho area to the Jordan River and Dead Sea in the east. ADS lands are luckily located between both Wadis which are attached to the north and east borders.

An optimistic quantity of flood water ranges from 3.0 to 10.0 MCM flows in both Wadis during 3 months of a rainy season (from Dec to Feb). This quantity of water can be utilized to improve the water resources and the quality of Quaternary Aquifer and will also provide additional water for agricultural development in Jericho area. The ADS area is highly recommended to implement such project, since it is characterized by intensive agricultural activities and most of the wells are exploited.

Moreover, several previous studies were carried out in several locations of the West Bank in order to identify the most potential wade's for artificial recharge; Wadi El-Qilt was selected to be the most favorable and suitable location for recharging groundwater in Jericho area (PWA, 2012).

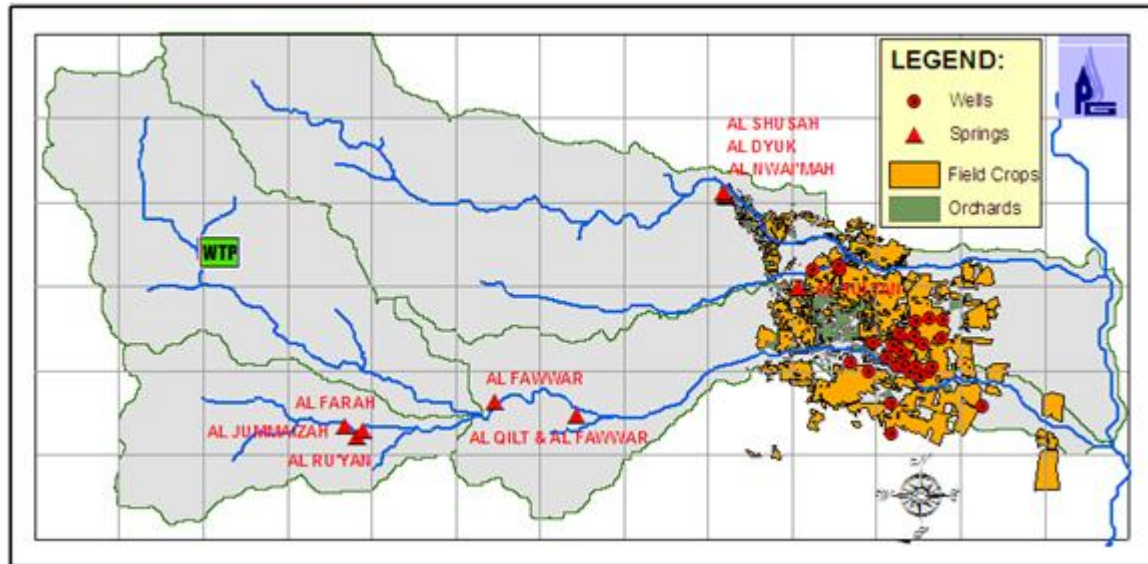

Figure 33: Map for the catchment area of Jericho Wadi's

Table 27: PWA measurement in Wadi Qelt

(1) Extracted from the 1998 FORWARD Report

No.	Date	Time of Measurement	Flood Discharge (m ³ /sec)	Flow area (m ²)	Mean Velocity (m/sec)
1	Jan. 19, 1974	10:40	3.08	2.15	1.44
2	- do -	12:30	3.99	3.02	1.32
3	- do -	13:40	4.02	2.81	1.43
4	Jan. 21, 1974	10:00	16.02	6.16	2.60
5	- do -	11:20	21.28	7.07	3.01
6	- do -	12:55	30.28	10.64	2.85
7	- do -	13:40	33.77	11.21	3.01
8	Jan. 22, 1974	9:15	9.79	4.32	2.27
9	Mar. 03, 1974	11:05	3.81	2.85	1.34
10	Mar. 04, 1980	12:00	2.78	2.74	1.01
11	Jan. 16, 1992	14:10	1.93	2.67	0.72
12	Feb. 18, 1992	14:45	2.51	2.74	0.92

Data Source: The 1998 FORWARD's Report

No.	Date	Flood Discharge Measured (m ³ /sec)
1	Apr. 18, 1971	0.89
2	Jan. 18, 1973	0.71
3	Mar. 03, 1980	2.36
4	Feb. 15, 1987	11.30
5	Feb. 03, 1988	18.11
6	Feb. 01, 1988	3.90
7	Dec. 02, 1991	6.48
8	Dec. 15, 1991	2.88
9	Jan. 07, 1992	7.60
10	- do - (after 4 hours)	8.81
11	Jan. 16, 1992	1.93
12	Jan. 25, 1992	1.93
13	Feb. 18, 1992	2.51
14	Feb. 06, 1992	18.48
15	Mar. 02, 1992	10.18
16	Dec. 20, 1992	17.45
17	Jan. 11, 1993	28.77
18	Jan. 11, 1993	15.21
19	Dec. 17, 1992	17.45
20	Nov. 24, 1994	1.40
21	- do - (after 3.5 hours)	5.29
22	Dec. 30, 1994	4.67

Data Source: PWA

The overall goal of the proposed scheme is to bridge the gap between water supply and demand in Jericho area and minimizes the adverse impact of water shortage during the dry-summer seasons by integrating the brackish water treatment with flash floodwater harvesting from Wadi Qilt during the winter seasons. The main objectives of the proposed scheme can be set as follows:

- Harvesting the flash floodwater in Wadi El-Qilt and preventing this water from being wasted by discharging to Jordan River or over the lands without any real benefit.
- By creating such interventions to collect, store and recharge the flash flood water to the aquifer, this will help in lowering the velocity of the flow and reduce the effects of soil erosions on both Wadi embankments.
- Increasing the potentiality of Quaternary Aquifer and minimizing the decline in the water level and salinity of this aquifer
- Providing additional suitable water for agricultural purposes, this project will increase water supply for agricultural sector and recreation areas in Jericho area
- Improving and developing the integrated management of surface and ground water resources for future perspectives.

Water Harvesting Ponds

- Water harvesting ponds is the most feasible technique for flood water harvesting that can be applied in the Jordan valley, pond realization shall consider the difficulties of estimating the discharge volume of the wadi, the concentration of suspended load that can cause reduction of a storage volume, the kind of intake facility to bring water to the pond and the land availability problems.
- The scope of work will comprise data collection and engineering designs necessary to implement the proposed harvesting technique in Wadi El-Qilt while the expected outcomes can be summarized as follows:
 - Water available for agriculture in Jericho will be increased
 - Social and economic life will be improved
 - Agricultural water purchasing price will be decreased
 - Health and sanitation conditions will be improved
 - Institutional set up for proper water distribution management will be established, and therefore local water management will be developed and improved

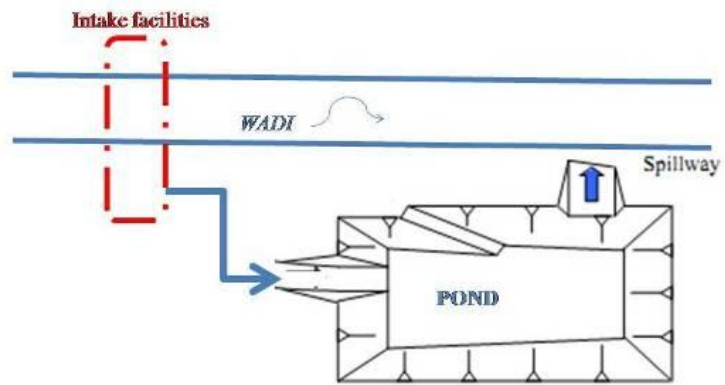

Figure 34: Schematic Diagram for a proposed Flood Water Harvesting Ponds, Source:(Ridini et al., 2013).

4.6.4.3. Installation of small scale Desalination Unit for the ADS

The tables below are evaluating the feasibility of installing a BWRO to desalinate the brackish water from ADS wells

Table 28: Cost parameters for installation BWRO

Operating cost parameter	Direct Energy, operation and maintenance man manpower, equipment's and parts replacement, chemical and other consumables
	Indirect Site lease or rent, Insurance, other overheads, Taxes and levies
Fixed costs parameters	Capital recovery Manpower ,part of equipment and part replacement, part of chemicals, site lease or rent , insurances, other overheads ,axes and levies
Variable costs parameters	Energy , most of equipment and parts replacements, most of chemicals
Main factors affecting costs	<ul style="list-style-type: none"> • Feed and product water qualities and process selection • Plant capacity – economy of scale • Local project cost financing, energy , etc) • Site specific conditions and their effect on infrastructure costs (raw water supply, brine disposal, energy supply product removal, etc.) • Method of bidding and contracting, level of competition and contractors profit margins

Table 28: BWRO key techno-economic parameters (ADAN, 2011)

Parameter	Units	BWRO
Membrane specific fluxes	l/m ² /h/bar	20 - 27
Membrane salt rejections	%	98.0 – 99.7
Plant operating pressures	Bar	10 -20
Membrane elements outputs	CM/D	40-48
8-inch element		80-96
16-inch element		
Membrane element costs	\$ (USD)	400 – 550
8-inch element		1,500 – 2,100
16-inch element		
Guaranteed membrane lifetime	Years	6-7
Pressure vessels	\$ (USD)	1,150 – 1,450
8-inch element		4,000 – 6,000

16-inch element		
High pressure pump costs	\$ (USD)	30,000 ¹¹
Specific energy requirement	Kwh/m ³	0.7 – 1.5 (\$0.09 – 0.19 (USD)) ¹²

Table 29: BWRO plants specific investment (ADAN, 2011)

Item	\$ (USD) / m ³ /day	% of Total
Site civil engineering works	30 – 50	5 - 7
Feed water supply subsystem	50 – 10	10-30
Product storage and delivery subsystem	10 – 50	2-10
Brine discharge subsystem	50- 180	10-30
Energy supply and distribution subsystem	20-35	4-5
Feed water pretreatment subsystem	25-100	5-15
Desalination units(s), including control and instrumentation	200- 280	35-45
Product post-treatment subsystem	15-35	3-5
Auxiliary subsystems	10-25	2-4
Total tangible or “hard “ costs	410-580	75-85
Engineering	25-45	5-7
Project management, administration & oversight	15-40	3-6
Permitting, legal, financing and other project development costs	35-70	7-10
Insurance and interest during construction	10-25	2-4
Total intangible or “soft” cost	85-150	15-35
Total project cost	500 - 700	100

Table 30: BWRO plants total water costs

Item	\$ (USD) / m ³	% of Total
Capital costs @7.5 average financing costs, 20 years amortization period, 96% annual utilization and no planed residual value	16-20	39-59
Operating costs Energy @ \$0.19 (USD)/ Kwh O&M manpower @ \$ 50,000 (USD)/man-year Equipment and parts replacement including membranes Chemicals and other consumables Site lease or rent , insurance, taxes Other overheads	14-25	41-61
Total operating costs		
Total water cost	30 – 45	100

¹¹ 100 CMH @ 20 bar selected from Grundfos catalogue

¹² Calculated based JEDCO commercial electricity tariff \$ 0.13 (USD)/ Kw

Chapter 5

5.1. Discussion and Results

The research highlighted the current agricultural water issues in the Jordan Valley, and tried to explore new feasible alternatives for brackish water desalination in order to utilize brackish water in the Jordan Valley.

To lower the cost, RO was combined with other alternatives such as utilizing the solar PV power, blending the brackish water with treated effluent or flood water harvested from Wade's run-off.

It has been proved that blending brackish water with treated effluent is a feasible alternative by considering the fact that JWWTP will generate 3.5MCM/Y when operated at ultimate capacity and this alternative can be optimized to include other areas in the Jordan when additional 15 MCM/Y conveyed to the Jordan valley from other cities.

The research recommended RO-PV after comparing the results of previous studies and the results of RO operating projects in Palestine. RO-PV was chosen for its economic feasibility of energy cost. Coupling RO to the off-grid solar PV lowered the cost to an average \$ 0.083 (USD)/CM as per calculated in Zbeidt desalination unit compared to \$ 0.166 USD/CM for Marj Na'ajeh RO unit supplied though the Electricity grid network. The average cost of desalinated water would still be cheaper if brackish water treatment combined with other alternatives such as blending with treated effluent or harvested run off.

Table 31: Comparison between different alternatives to utilize brackish water at ADS

Alternative	Capital Cost \$ (USD)	O&M Cost \$(USD) / M ³	Total production CM/H	Advantages	Potential for land development (ha)	Constrains
Small scale BWRO unit Power supply " Electricity Grid "	70000	0.166	100	Market availability Simplicity of maintenance and operating. High quality water	73 ¹³	Economic and Environmental constrains High Energy consumption Required Brine treatment Loss of nutrients and minerals required for agriculture.
RO coupled to the off-grid solar PV	160 000	0.083	100	Low cost, Low energy consumption High quality water Green energy and low carbon emissions	73 ¹⁴	High capital cost Limited performance in winter Space required for PV plant
Brackish water blended with treated effluent	120 000 ¹⁴	0.23 ¹⁵	100	Low cost, Low energy consumption Good quality Advantage of Nutrients and minerals in the treated effluent	73 ¹⁴	Land required for mixing tank Pre-treatment will be required Sensitivity to the annual rain fall
Brackish water blended with harvested run off.	140 000 ¹⁶	0.25 ¹⁷	100	Low cost, Low energy consumption	73 ¹⁴	

¹³ The calculations are based on Palm trees water requirements of 12000 CM/Y/ha ((100 CM/H*24 Hr*365 day)/12000 CM/Y)

¹⁴ (Construction of 10 000 CM earth pool to be used as a mixing tank \$ 78,000 (USD + Pump station 100 CM/H and pipeline \$ 40,000 (USD) details in (Annex 7)

¹⁵ The price for 1 M³ of treated effluent from JWWTP is (USD) 0.09 + pumping cost from JWWTP to the mixing tank in ADS premises

¹⁶ Cost details (Construction of 10 000 CM earth pool to be used as a mixing tank \$ 78,000 (USD) + Pre-filtration unit 400 CMH \$ 20,000 (USD) + Pump station 100 CMH \$ 40,000 (USD) details in (Annex x)

¹⁷ The cost of 1 M³ of brackish blended with harvested run off is \$ 0.25 (USD) which includes (Pumping of brackish water to the mixing tank + pre-filtration for harvested run off + pumping cost from to the mixing tank to the internal network in ADS premises (costs are detailed in annex 6)

5.2. Questionnaire Results

5.2.1. Satisfaction to Agricultural water cost

Table 31 (Annex 6): shows that 42% of respondents consider that the cost for Agricultural water is high and of significant effects on the production (56%), while 10 % has considered the cost as Very high, whereas 62% of respondents believe that water cost shouldn't exceed 10% of the total income and 68% believe that price for one cubic meter should be between 0.2 to 0.4 NIS.

5.2.2. Satisfaction to the Water Quality

As shown in Table 32 (Annex 6), only 14 % of respondents receive agricultural water of low salinity (Less than 1000 ppm) while (56%) are supplied with brackish water of medium salinity (1000 – 3000 ppm) and the rest of respondents (30 %) are supplied with moderately high salinity water of more than 3000 ppm. However the response shows that the majority of respondents have experienced scaling problems in their water networks but, less than 16% had problems of suspended solids or turbidity problems.

5.2.3. Respondents Awareness and Willingness to accept the use of Desalinated water and Treated Effluent

In Table 33 (Annex 6), 56% of respondents responded negatively to the question about their awareness or knowledge on desalination and effluent Reuse while only 44% has shown good to very good knowledge in this regard. However, it was very clear that the majority of respondents are against the reuse of treated effluent (48% gave the answer No and 24% were extremely against). The main reasons behind the rejection of treated effluent were related to health concerns (40%) and quality concerns (28%), however, their opinion has been changed to the use of Blended water (brackish water and treated effluent) as 58% were positive to the use of Blended water.

Contrary to the response to the reuse of Treated Effluent, 94% positively responded to the use of desalinated water. The reasons behind the positive response to the use of desalinated and blended water vary between economic considerations, water shortage and Environmental aspects; furthermore, 72% of respondents believe that the reuse of desalinated water and treated effluent is enough to bridge the gap between the demand and supply for agricultural water.

5.2.4. Farm management

The purpose of this section is to understand and assess the respondents management of their farms in terms of cultivation type, irrigation method and the potential lands available for future development, From Table 34 (Annex 6) it is found that vegetables represent 66% of the cultivated land according to the respondents answers , while the rest 33 % are

distributed between citrus, palm trees, animal fodder and other crops, the results have also shown that all the respondents are applying the drip irrigation method in their farms.

The respondents considered that the main problem facing agriculture in the Jordan Valley is marketing (34%) and water shortage (30%) while less importance was given to the cost and supervision. Respondents concerns about applying the desalination technology vary between cost (38%), increasing soil salinity (22%); whereas less importance has been given to water loss as brine.

5.3. Conclusion

From humanitarian and environmental perspectives, Palestine faces sever water challenges pertinent to accessibility, institutional and water management. This research underlines the importance of the brackish water desalination and the use of reclaimed effluent in Jericho district as additional unconventional water sources for agricultural irrigation and drinking water purposes. Currently, the RO desalination of brackish water is the most commonly used technology in Palestine. Due to political reasons and signed water treaty, Israel limits digging new groundwater wells in Jericho district, thus preventing the expansion of agricultural production in the West Bank, and impedes the import of desalination systems or provision of electrical power needed for the operation of large desalination plants.

This research has concluded that the most feasible desalination technology is the RO-PV; this has been also proved by different published studies and the results of implemented projects in Palestine. However, R.O technology is still considered as an expensive solution to be tackled by low-income farmers in the Jordan Valley. Therefore, another alternative has been proposed to alleviate the high cost of desalination to a reasonable level suitable for normal farmers and small agricultural enterprises.

For the case study (ADS wells), the most feasible alternative from economical and environmental perspective for utilizing the brackish is by blending with treated effluent from nearest the WWTP in Jericho city.

The following conclusions also emerged from this study:

- Integrated scheme combining desalination of brackish water with effluent reuse and flood Run Off would be one of the most suitable solutions to improve the water resources in the Jordan Valley and bridge the gap between supply and demand.
- Water scarcity in many countries has brought about significant progress in the use of non-conventional resources (desalination and effluent reuse).

- Jordan and Israel experience has demonstrated that even desalination cost is still expensive but it can be considered as feasible alternative and can be incorporated in overall production costs (even for private initiatives)
- Cost of desalination of brackish water can be competitive but can't be assumed by all the end-users, even the agricultural industry.
- Desalination of inland brackish water raises problems even not well solved due to the brine discharges or brine disposal, and it's necessary to research more about this important topic

5.4. Recommendations

- The cost of desalinated water and treated effluent is still high to be handled by the farmers; this implies investigating new alternatives to lower the cost and empowers their affordability.
- The desalination technology needs a comprehensive management system, to organize the desalination plants distribution based on brackish water availability, areas' needs and capacity.
- Monitoring program for the desalinated plants should be developed for evaluating the product and distributed water.
- To avoid the negative environmental impact, the disposal of brine should be considered and EIA must be conducted.
- Awareness campaign targeting the consumers to increase their awareness about the drinking water recommendations and healthy water quality.
- Palestine is in a great need for capacity building in the field of water desalination technology.
- Further researches on feasibility of desalination and effluent reuse will be needed in order to improve the efficiency and minimize the cost.

References

1993. Sea water desalination in California / Potential environmental coastal act issues. California Coastal Commission
- ABU-JABAL, M. D. S., KAMIYA, I. & NARASAKI, Y. 2001. Proving test for a solar-powered desalination system in Gaza-Palestine. *Desalination*, 137, 1-6.
- ABUELHAIJA, I. 2013 Marj Na'jeh Desalinating Prject with MoA.
- ADAN 2011. Desalination Training Program for Professional and the Hashemite Kingdom of Jordan. Israel ADAN Technical & Economic Services Ltd.
- AL-AGHA, M. R. & MORTAJA, R. S. 2005. Desalination in the gaza strip: drinking water supply and environmental impact. *Desalination*, 173, 157-171.
- AL-HADIDI, M. S. 1999. Brackish water management and use in Jordan. *Desalination*, 126, 41-44.
- AL-KARAGHOULI A, L. L. K. 2011. Renewable Energy Opportunities in water desalination. *National Renewable Energy Laboratory*
- AL-NAJAH 2012. Quality Analysis Report fo Zbeidat Desalination Plant.
- AL-SA'ED, R. 2006. Wastewater Management in Jericho: Challenges & Possible Solutions. *Jericho Environmental Conference*.
- AMNESTY 2009. TROUBLED WATERS – PALESTINIANS DENIED FAIR ACCESS TO WATER
United Kingdom: Amnesty International International Secretariat.
- ARGES 2013. Technical Specification of Modular Wastewater Treatment Unit *In: ARGES (ed.)*.
- ARIJ 1995. Environmental Profile for The West Bank -Jericho District Jerusalem
- ARIJ 1998. Water Resources and Irrigated Agriculture. Jerusalem, Palestine: Applied Research Institute
- ARIJ 2011. The economic costs of the Israeli occupation for the occupied Palestinian territory.
- B'TSELEM 2011. Dispossession and Exploitation: Israel's Policy in the Jordan Valley and Northern Dead Sea B'Tselem.
- BANK, W. 2009. *World bank annual reports* [Online]. World Bank. Available: <http://web.worldbank.org/WBSITE/EXTERNAL/COUNTRIES/MENAEXT/WESTBANKGAZAEXTN/0,,menuPK:294391~pagePK:64026187~piPK:141126~sortDesc:DOCDT~theSitePK:294365,00.html> [Accessed April 2014 2014].
- BEN-GAL, A., YERMIYAHU, U. & COHEN, S. 2009. Fertilization and Blending Alternatives for Irrigation with Desalinated Water All rights reserved.. *J. Environ. Qual.*, 38, 529-536.
- BROWN, O. & CRAWFORD, A. 2009. Rising Temperatures, Rising Tensions: Climate change and the risk of violent conflict in the Middle East. International Institute for Sustainable Development.
- BRYANT, E. A. 1992. *Disinfection Alternatives for Safe Drinking Water*, New York, Van Nostrand Reinhold.
- BSHARAT, J. 2012. Cost Estimation for drilling of new shallow well in Jericho area Jericho Municipality
- CENTER, M. D. 2010. To Exist is To Resist: Save the Jordan Valley. Palestine.
- DOMINGO ZARZO MARTINEZ, C. G. G. S. A. R. B. C. 2009. Experiences on Desalination of Different Brackish Water. *Candel IDA World Congress – Atlantis, The Palm*. Dubai, UAE.
- DREIZIN, Y., TENNE, A. & HOFFMAN, D. 2008. Integrating large scale seawater desalination plants within Israel's water supply system. *Desalination*, 220, 132-149.

- EL-BANA 2000. Desalination Technology *El Dar El Amelia*, 110 - 120
- EL-DESSOUKY, H. T. & ETTOUNEY, H. M. 2002. *Fundamentals of salt water desalination*, ELSAVIER.
- EL-GHONEMY, A. M. K. 2013. Retraction notice to “A small-scale Brackish water reverse-osmosis desalination system used in northern of Saudi Arabia, case study” [Renewable Sustainable Energy Rev. 16 (2012) 4597–4605]. *Renewable and Sustainable Energy Reviews*, 24, 628.
- FAO. 2012. *Aquastat: Occupied Palestinian Territory* [Online]. FAO. Available: http://www.fao.org/nr/water/aquastat/countries_regions/wbgs/index.stm [Accessed November 2012].
- GEORGOPOULOU, E., KOTRONAROU, A., KOUSSIS, A., RESTREPO, P. J., GÓMEZ-GOTOR, A. & RODRIGUEZ JIMENEZ, J. J. 2001. A methodology to investigate brackish groundwater desalination coupled with aquifer recharge by treated wastewater as an alternative strategy for water supply in Mediterranean areas. *Desalination*, 136, 307-315.
- GLUECKSTERN, P. 1991. Cost estimates of large RO systems. *Desalination*, 81, 49-56.
- HOCHSTRAT, R., WINTGENS, T., MELIN, T. & JEFFREY, P. 2006. Assessing the European wastewater reclamation and reuse potential — a scenario analysis. *Desalination*, 188, 1-8.
- HODGKIN & CHRISTIAN, E. 1953-1984. Arab development society collection. Arab Development Society (1945-).
- HUZAIBI. 2013 *RE: Desalination unit in COPSCO Co.* Type to BSHARAT, J.
- IEICI. 2013. *Israel's Agriculture* [Online]. The Israel Export & International Cooperation Institute. Available: [http://www.moag.gov.il/agri/files/Israel's Agriculture Booklet.pdf](http://www.moag.gov.il/agri/files/Israel%20Agriculture%20Booklet.pdf) [Accessed January 2013].
- ISMAIL, M. 2003. *Prospects of Water Desalination in the Gaza Strip*
KTH Land and Water
Resources Engineering
- JERICO-MUNICIPALITY. 2013. *Jericho Master Plan - Alternative I.* Palestine - Jericho: Jericho Municipality
- JICA 2006. Jericho Regional Development Study Project in Palestine Japan International Cooperation Agency.
- JIMENEZ, B., CHAVEZ, A., MAYA, C. & JARDINES, L. 2001. Removal of microorganisms in different stages of wastewater treatment for Mexico City. *Water Sci Technol*, 43, 155-62.
- KAZMERSKI, A. A. A.-K. A. L. L. 2011. *Renewable Energy Opportunities in Water Desalination, Desalination, Trends and Technologies.*
- KHAYAT, S., HÖTZL, H., GEYER, S. & ALI, W. 2006. Hydrochemical investigation of water from the Pleistocene wells and springs, Jericho area, Palestine. *Hydrogeology Journal*, 14, 192-202.
- KUBI, M. A. 2003. DETECTION AND MAPPING OF THE LAND USE/LAND COVER (LULC) CHANGES IN THE “JORDAN VALLEY” USING LANDSAT IMAGERIES. Jerusalem - Palestine: Applied Research Institute -Jerusalem (ARIJ).
- LAWRENCE, P., ADHAM, S. & BARROTT, L. 2003. Ensuring water re-use projects succeed — institutional and technical issues for treated wastewater re-use. *Desalination*, 152, 291-298.
- MAAN 2012a. Spotlight 10: The Status of Palestinian Agriculture in the Jordan Valley. MA'AN Development Center.
- MAAN. 2012b. *The Status of Palestinian Agriculture in the Jordan Valley* [Online]. Available: <http://www.maan-ctr.org/pdfs/FSReport/spotlight/Spotlight10.pdf> [Accessed March 10 2014].
- MARIE, A. & VENGOSH, A. 2001. Sources of Salinity in Ground Water from Jericho Area, Jordan Valley. *Ground Water*, 39, 240-248.

- MEDINA, J. A. A. 2004. Feasibility of water desalination for agriculture. *In: J. MARTÍNEZ BELTRÁN, S. K.-O. (ed.) FAO Expert Consultation on Water Desalination for Agricultural Applications* Rome (Italy): FAO, Rome (Italy).
- MOA & PWA 2010. Jordan Valley Development Plan
- MOHSEN, M. S. & AL-JAYYOUSI, O. R. 1999. Brackish water desalination: an alternative for water supply enhancement in Jordan. *Desalination*, 124, 163-174.
- MOHSEN, M. S. & GAMMOH, S. 2010. Performance evaluation of reverse osmosis desalination plant: A case study of Wadi Ma'in, Zara and Mujib Plant. *Desalination and Water Treatment*, 14, 265-272.
- NIPPON KOEI CO., L. J. S. T. 2008. Water Resources Development and Management in the Jordan Valley. Ramallah, Palestine: Japan International Cooperation Agency.
- NJS 2013. TECHNICAL ASSISTANCE AND CAPACITY - BUILDING PROJECT FOR THE JERICHO SANITATION PROJECT - Description of JWWTP. NJS CONSULTANTS CO., LTD.
- YOKOHAMA WATER CO., LTD.
- O. JABER, J. & S. MOHSEN, M. 2001. Evaluation of non-conventional water resources supply in Jordan. *Desalination*, 136, 83-92.
- OXFAM 2012. On the brink: Israeli settlements and their impact on Palestinians in the Jordan Valley. Oxfam.
- PCBS 2007. Localities in Jericho & Al Aghwar Governorate by Type of Locality and Population Estimates. Palestine Palestinian Central Bureau of Statistics
- PHG 2010. Water Master Plan for Jericho city. Ramallah, Palestine: Palestinian Hydrology Group.
- PITMAN, M. & LÄUCHLI, A. 2002. Global Impact of Salinity and Agricultural Ecosystems. *In: LÄUCHLI, A. & LÜTTGE, U. (eds.) Salinity: Environment - Plants - Molecules*. Springer Netherlands.
- PWA 2006. Annual Status Report on water resources, Water Supply, and Wastewater in the Occupied State of Palestine
- PWA 2011. Annual Status Report on water resources, Water Supply, and Wastewater in the Occupied State of Palestine. Ramallah - Palestine Palestinian Water Authority
- PWA. 2013. *Jericho Wells* GIS Department - PWA.
- PWA, P. W. A. 2012. Palestinian water sector: status summary report in preparation for the meeting of the Ad Hoc Liaison Committee (AHLIC). New York.
- QOTOB, M. 2014
- RIDINI, M., BATTALINGI, L. & PACCETI, T. 2013. Jericho Municipality Master Plan on Urban Surface Water Management. Jericho European Union.
- SALAH, Y., ABUMAYLA, SALEEM, S. & AMR, A. 2010. Chemical and microbiological quality of drinking water in Gaza Strip, Palestine *Scinec vision*.
- SALEH, A. I. A. 2007. *IMPACT OF PUMPING ON SALTWATER INTRUSION IN GAZA COASTAL AQUIFER, PALESTINE*. Master Degree, An-Najah National University.
- SHAHEEN, H. Q. 2003. Wastewater Reuse as Means to Optimize the Use of Water Resources in the West Bank. *Water International*, 28, 201-208.
- SHAIEB, B. 2013 *RE: Desalination Plant in Zbeidat*
- TAHA, M. 2014. *Feasibility of Small Scale Renewable Desalination Units Application in the Jordan Valley*. Master Degree Simenar Birzeit University
- TENNE, A., HOFFMAN, D. & LEVI, E. 2012. Quantifying the actual benefits of large-scale seawater desalination in Israel. *Desalination and Water Treatment*, 51, 26-37.
- UNICEF & GVC. 2010. *RE: Assessment of Water Availability and Access in the Areas*

Vulnerable to Drought in the Jordan Valley.

VENGOSH, A. & ROSENTHAL, E. 1994. Saline groundwater in Israel: its bearing on the water crisis in the country. *J Hydrol*, 156, 389–430.

VENGOSH, A. & ROSENTHAL, E. 1994. Saline groundwater in Israel: its bearing on the water crisis in the country. *Journal of Hydrology*, 156, 389-430.

WB 2009. Assessment of Restrictions on Palestinian Water Sector Development.

ZAHID AMJAD, J. F., JOHN F. ZIBRIDA, ROBERT W. ZUHL 1998. *Reverse Osmosis Technology: Fundamentals and Water Applications**, Lubrizol Advanced Materials, Inc.

Annex 1: Agricultural Wells in the Jordan Valley (PWA, 2013)

ID	Well Id	Location	Usage	X coordinates	Y coordinates	Z Coordinates	Licensed Abstraction (m3/year)	Well Depth (m)	Licensed Abstraction (m3/hr)	Area Required to implement Solar Still option (dunum)
1	18-18/001	Ras Al-Far'a	agricultural	181050	188620	220	267,000	30	41	
2	18-18/002	Ras Al-Far'a	agricultural	182200	188350	180		125		
3	18-18/004	Ras Al-Far'a	agricultural	181910	188710	180	183,000	84	28	
4	18-18/016	Ras Al-Far'a	agricultural	182370	188890	175	224,000	78	34	
5	18-18/025		agricultural	186800	182500		50,000		8	52
6	18-18/026	Wadi Al Far'a	agricultural	186800	182500	-15	50,000	55	8	52
7	18-18/032	Ras Al-Far'a	agricultural	182120	188950	197.2	241,000	70	37	
8	18-18/033	Ras Al-Far'a	agricultural	182140	189770	213.32	46,000	125	7	48
9	18-18/042		agricultural	-	-	-	-	250	-	
10	18-18/043	Tobas	agricultural	-	-	-	-	200	-	
11	18-18/044		agricultural	-	-	-	-	200	-	
12	18-18/047	Tobas	agricultural	-	-	-	-	100	-	
13	18-18/049	Tobas	agricultural	-	-	-	-	150	-	
14	18-18/050	Tobas	agricultural	-	-	-	-	130	-	
15	18-18/051	Tobas	agricultural	-	-	-	-	180	-	
16	18-18/054	Tobas	agricultural	-	-	-	-	302	-	
17	18-18/055	Tobas	agricultural	-	-	-	-	-	-	
18	18-18/056	Tobas	agricultural	-	-	190	-	275	-	
19	18-18/057	Tobas	agricultural	184158	186956	153	-	220	-	
20	18-18/058	Jenin	agricultural	-	-	126	-	233	-	
21	18-18/062	Tobas	agricultural	-	-	-	-	83	-	
22	18-18/063		agricultural	-	-	-	-	76	-	
23	18-18/064		agricultural	-	-	-	-	-	-	
24	18-18/065	Ras AlFar'a	agricultural	-	-	-	-	-	-	
25	18-18/17		agricultural	-	-	-	-	-	-	
26	18-18/25A	Ras Al-Far'a	agricultural	181650	189540	220	212,000	92	32	
27	18-18/27	Wadi Al Far'a	agricultural	186060	183610	-18.385	24,000	60	4	25
28	18-18/4	Jenin	agricultural	-	-	-	-	84	-	
29	18-18/41A		agricultural	-	-	-	-	58	-	
30	18-18/46	Tobas	agricultural	-	-	-	-	90	-	
31	18-19/001	Tobas	agricultural	-	-	-	-	250	-	
32	18-19/002	Tobas	agricultural	181607	190945	326	-	332	-	
33	18-19/003	Tobas	agricultural	-	-	-	-	-	-	
34	19-19/005A	Bardala	agricultural	198980	197226	-161	238,000	50	36	
35	19-19/005B		agricultural	199848	197296	-161	74,000	50	11	
36	19-19/006A		agricultural	-	-	-	41,000	38	6	43
37	19-19/006B		agricultural	197001	199432	-112	158,000	51	24	
38	19-19/007A		agricultural	198948	199667	-164	169,000	65	26	
39	19-19/009A		agricultural	-	-	-	626,000	37	95	
40	19-19/009B		agricultural	-	-	-	950,000	65	145	
41	19-20/001A		agricultural	-	-	-	16,000	30	2	17
42	798	Tamun	agricultural	188529	187271	269	-	400	-	
43	334	Jericho	agricultural	-	-	-	-	-	-	
44	20-17/009	Marj Na'ja	agricultural	200648	175585	-234	-	-	-	
45	20-17/010	Marj Na'ja	agricultural	200997	176842	-231	205,000	76	31	
46	20-17/011	Marj Na'ja	agricultural	201221	176911	-250	194,000	91.7	30	
47	20-17/016	Marj Na'ja	agricultural	200340	175861	-224	150,000	90	23	
48	20-17/018	Marj Na'ja	agricultural	200247	175682	-241	375,000	69	57	
49	20-17/019	Marj Na'ja	agricultural	-	-	-	20,000	76.5	3	21
50	20-17/022	Marj Na'ja	agricultural	200968	178214	-226	73,000	103	11	
51	20-17/023		agricultural	201420	178367	-226	59,000	100	9	62
52	20-18/012A	Marj Na'ja	agricultural	202100	182438	-241	41,000	90	6	43
53	19-13/005	Jericho (Ariha)	agricultural	-	-	-	140,000	104	21	
54	19-13/005A	Jericho (Ariha)	agricultural	-	-	-	140,000	104	21	
55	19-13/006	Jericho (Ariha)	agricultural	195500	139580	-288	125,000	57	19	
56	19-13/015	Jericho (Ariha)	agricultural	196100	139510	-292.686	-	138	-	
57	19-13/015A	Jericho (Ariha)	agricultural	196100	139510	-	92,000	137	14	
58	19-13/018	Jericho (Ariha)	agricultural	193770	139750	-260	39,000	90	6	41
59	19-13/020	Jericho (Ariha)	agricultural	194320	139480	-270	405,000	83	62	
60	19-13/021	Jericho (Ariha)	agricultural	194960	138560	-279	370,000	72	56	
61	19-13/022	jericho	agricultural	194250	138500	-272	-	-	-	
62	19-13/027A	jericho	agricultural	-	-	-	-	-	-	
63	19-13/042	jericho	agricultural	193700	139670	-260	31,000	70	5	32
64	19-13/047	Jericho (Ariha)	agricultural	194850	139880	-278.3	259,000	74	39	
65	19-13/048	Jericho (Ariha)	agricultural	195310	139660	-285	244,000	57	37	
66	19-13/049	Jericho (Ariha)	agricultural	195530	139480	-290	60,000	70	9	63
67	19-13/050	jericho	agricultural	195810	139380	-290	122,000	120	19	
68	19-13/050A	Jericho (Ariha)	agricultural	195810	139380	-290	136,000	100	21	
69	19-13/051	jericho	agricultural	195710	139640	-286	30,000	75	5	31
70	19-13/052	Jericho (Ariha)	agricultural	195880	139670	-289	241,000	120	37	
71	19-13/055	Jericho (Ariha)	agricultural	196200	139640	-295	22,000	110	3	23
72	19-13/061	jericho	agricultural	196650	139940	-299.86	28,000	54	4	29
73	19-13/068	jericho	agricultural	191250	139850	-220	55,000	90	8	57
74	19-13/069	Jericho (Ariha)	agricultural	196950	139250	-315	50,000	132	8	52
75	19-13/51A	jericho	agricultural	-	-	-	-	-	-	
76	19-14/001	Al Auja	agricultural	195973	150055	-236	74,000	59	11	
77	19-14/002	Jericho (Ariha)	agricultural	192685	142572	-197	16,000	150	2	17
78	19-14/003	jericho	agricultural	193392	143300	-184	-	-	-	
79	19-14/005	Jericho (Ariha)	agricultural	194440	140340	-265.44	63,000	65	10	66
80	19-14/008	jericho	agricultural	195190	140350	-277.808	67,000	54	10	
81	19-14/009	Jericho (Ariha)	agricultural	195230	140530	-277	73,000	70	11	
82	19-14/010	Jericho (Ariha)	agricultural	195220	140610	-277	137,000	66	21	
83	19-14/012	Jericho (Ariha)	agricultural	195380	140010	-282	180,000	79	27	
84	19-14/013	jericho	agricultural	194910	140000	-275	24,000	62	4	25
85	19-14/014	jericho	agricultural	194550	140140	-268.207	129,000	71	20	
86	19-14/015	Jericho (Ariha)	agricultural	195670	140530	-285	149,000	93	23	
87	19-14/017	jericho	agricultural	195920	140310	-290	110,000	68	17	
88	19-14/017A	jericho	agricultural	195920	140310	-290	110,000	68	17	
89	19-14/019	Jericho (Ariha)	agricultural	196460	140500	-291.85	110,000	67	17	
90	19-14/020	Jericho (Ariha)	agricultural	196490	141020	-295	50,000	60	8	52
91	19-14/021	jericho	agricultural	196210	140980	-288	70,000	77	11	
92	19-14/023	Jericho (Ariha)	agricultural	195040	140240	-270	94,000	60	14	
93	19-14/024	Jericho (Ariha)	agricultural	195260	140140	-280	120,000	65	18	
94	19-14/037	Jericho (Ariha)	agricultural	196184	141093	-266	75,000	83	11	
95	19-14/038	Jericho (Ariha)	agricultural	193523	142580	-210	134,000	110	20	
96	19-14/040	jericho	agricultural	193710	142360	-244.005	53,000	92	8	55
97	19-14/049	jericho	agricultural	195930	141630	-275	11,000	90	2	11
98	19-14/052	Jericho (Ariha)	agricultural	195758	141032	-258	180,000	82	27	
99	19-14/054	jericho	agricultural	195500	141630	-274	161,000	83	25	
100	19-14/058	Jericho (Ariha)	agricultural	-	-	-	59,000	63	9	62
101	19-14/058A	Jericho (Ariha)	agricultural	195040	141280	-270	20,000	40	3	21
102	19-14/062	Jericho (Ariha)	agricultural	193452	142680	-196	147,000	120	22	
103	19-14/064	jericho	agricultural	197270	141214	-291	50,000	90	8	52
104	19-14/066	jericho	agricultural	197350	140726	-284	50,000	33	8	52
105	19-14/067	jericho	agricultural	197009	140828	-280	50,000	73	8	52
106	19-14/070	jericho	agricultural	196890	140670	-305	50,000	250	8	52
107	19-14/073	jericho	agricultural	197030	141050	-280	50,000	100	8	52
108	19-14/073A	jericho	agricultural	197030	141040	-282	50,000	8	8	52

Annex 1: Agricultural Wells in the Jordan Valley (PWA, 2013)

ID	Well Id	Location	Usage	X coordinates	Y coordinates	Z Coordinates	Licensed Abstraction (m3/year)	Well Depth (m)	Licensed Abstraction (m3/hr)	Area Required to implement Solar Still option (dunum)
109	19-14/080	Jericho	agricultural	197173	141895	-280	50,000	100	8	52
110	19-14/081	Jericho	agricultural	197127	142358	-276	50,000	100	8	52
111	19-14/102	Jericho	agricultural	193961	143747	-213	-	100	-	-
112	19-14/103	Jericho	agricultural	193737	143830	-206	-	120	-	-
113	19-14/104	Jericho	agricultural	192977	140992	-212	-	237	-	-
114	19-14/105	Jericho	agricultural	192817	141524	-207	-	135	-	-
115	19-15/005	Al'Auja	agricultural	194777	150408	-201	65,000	108	10	68
116	19-15/007	Al'Auja	agricultural	194907	150793	-233	164,000	105	25	-
117	19-15/008	Al'Auja	agricultural	195983	151412	-252	-	100	-	-
118	19-15/010	Al'Auja	agricultural	194560	151116	-216	88,000	102	13	-
119	19-15/011	Al'Auja	agricultural	194812	151057	-222	128,000	95	19	-
120	19-15/012	Al'Auja	agricultural	194631	150998	-224	133,000	103	20	-
121	19-15/013	Al'Auja	agricultural	194620	151450	-	-	96	-	-
122	19-15/015	Al'Auja	agricultural	196235	151211	-239	76,000	47	12	-
123	19-15/019	Al'Auja	agricultural	195671	150973	-256	-	120	-	-
124	19-15/023	Al'Auja	agricultural	196166	150125	-235	94,000	41	14	-
125	19-16/001	Al Jiftlik	agricultural	196836	169616	-232	420,000	68	64	-
126	19-16/003	Al Jiftlik	agricultural	198701	169606	-253	48,000	75	7	50
127	19-16/004	Al Jiftlik	agricultural	198912	169182	-254	155,000	93	24	-
128	19-16/005	Al Jiftlik	agricultural	199571	168946	-263	89,000	68	14	-
129	19-16/006	Fasayil	agricultural	191537	160324	-197	95,000	151	14	-
130	19-16/008		agricultural	196780	169670	-260	258,000	66	39	-
131	19-16/009	Al Jiftlik	agricultural	197547	168200	-252	118,000	75	18	-
132	19-16/010	Al Jiftlik	agricultural	197041	169235	-233	170,000	76	26	-
133	19-17/001	Al Jiftlik	agricultural	196811	170932	-229	149,000	90	23	-
134	19-17/002	Al Jiftlik	agricultural	196580	171256	-225	183,000	90	28	-
135	19-17/004	Al Jiftlik	agricultural	197220	170560	-260	17,000	92	3	18
136	19-17/006	Al Jiftlik	agricultural	196828	169873	-229	275,000	69	42	-
137	19-17/007	Al Jiftlik	agricultural	197905	172306	-225	39,000	74	6	41
138	19-17/008	Al Jiftlik	agricultural	196302	170301	-217	521,000	72	79	-
139	19-17/009	Al Jiftlik	agricultural	197530	170357	-239	138,000	91	21	-
140	19-17/010	Al Jiftlik	agricultural	197135	170116	-233	83,000	77	13	-
141	19-17/011	Az Zubeidat	agricultural	199872	174915	-243	77,000	72	12	-
142	19-17/012	Marj Al Ghazal	agricultural	199730	174726	-236	-	-	-	-
143	19-17/020	Az Zubeidat	agricultural	200005	175104	-237	292,000	91	44	-
144	19-17/021	Al Jiftlik	agricultural	196607	170618	-231	477,000	81	73	-
145	19-17/023	Al Jiftlik	agricultural	-	-	-	45,000	150	7	47
146	19-17/024	الجابك	agricultural	196515	171587	-216	150,000	62	23	-
147	19-17/027	Al Jiftlik	agricultural	196311	171499	-219	274,000	116	42	-
148	19-17/028	Al Jiftlik	agricultural	198220	170514	-240	88,000	72	13	-
149	19-17/031	Al Jiftlik	agricultural	197738	171095	-235	121,000	100	18	-
150	19-17/033	Al Jiftlik	agricultural	196579	172950	-218	56,000	57	9	58
151	19-17/034	Furush Beit Dajan	agricultural	192795	178413	-118	126,000	201	19	-
152	19-17/043	Furush Beit Dajan	agricultural	194268	175229	-176	121,000	119	18	-
153	19-17/044	Furush Beit Dajan	agricultural	192051	179052	-108	91,000	117	14	-
154	19-17/045	Furush Beit Dajan	agricultural	191932	179060	-97	13,000	113	2	14
155	19-17/046	Furush Beit Dajan	agricultural	192621	176279	-145	195,000	147	30	-
156	19-17/047	Furush Beit Dajan	agricultural	192790	178997	-111	46,000	140	7	48
157	19-17/050	Furush Beit Dajan	agricultural	192790	179120	-125.046	75,000	134	11	-
158	19-17/051	Furush Beit Dajan	agricultural	192222	179342	-102	-	95	-	-
159	19-17/053	Al Jiftlik	agricultural	196806	170660	-235	62,000	73.5	9	65
160	19-17/054	Al Jiftlik	agricultural	197760	169988	-243	94,000	75	14	-
161	19-17/055	Al Jiftlik	agricultural	196328	173336	-209	300,000	130	46	-
162	19-17/056	Al Jiftlik	agricultural	195234	173854	-203	330,000	147	50	-
Total Licensed Well Capacity							16,630,000		2,531	1,825

(annex 2)

Checklist for Desalination Plant's in Jericho Area

Name: COPSCO Desalinating plant for brackish water

1. General	
1.1 Location of the WTP	Jericho city – Consolidated Palestinian Co.
1.2 Donor	Private ownwrship (COPSCO)
1.3 Implementing Agency	COPSCO
1.4 Designer of the WTP	ARC ARTIMA TEKNOLGIS - Turkey
1.5 Manufacturer of the WTP	ARC ARTIMA TEKNOLGIS - Turkey
1.6 Operator of the WTP	COPSCO technical staff
1.7 Operating hours	7 Hours/Day
1.8 Establishment year	2012
1.9 Capacity of the WTP	15 M ³ :(Hr 105 M ³ /Day)
1.10 Treatment technology	Pre-treatment (sand Filtration + catridge filters)– R.O - Disinfection
2. Status of Effluent	
1.9 Infflunet source	Ground water well – Main water tank
2.1 Infflunet Quality	TDS: 6000 PPM Na: Cl: HCO3:
3. Specify the units included in WTP :	
Equilizing tank	Found x Not found Supplied Directly from the well
Intake pump	Found x Not found Supplied directly from the well
R.O unit	x Found Not found Q: 30 M ³ / Hr Hmax: 116.8m Hmin: 94m
Disifiction unit	x Found Not found
Brine disposal method	Found x Not found Discharged directly to the neighbouring wadi
PH adjustment method	x Found Not found Acid enjection 100 lieter tank + Dosing pump
Unti-scalent unit	x Found Not found 100 lieter tank + Dosing pump
PV plant (Power Supply)	x Found Not found
Others CIP unit (Clean in Place)	x Found Not found Washout of Pumps and Membranes 1000 lit tqank + Pump of 1.2 M ³ /Hr @ 10 m

	Head
1.3 List any other chemical and their use	
4. Status of Effluent	
4.1 Are there analyses for the Permate	x Yes No
4.2 Permate analysis (Main parameter's)	TDS: 350 - 450 PPM Na: Cl: HCO3:
4.3 Are the results of the analysis comply with the palestininan standards.	Agricultural use x Yes No Domestic use x Yes No
4.4 What is the procedure of disinfection.	x Sodium Hypochloride UV Other's : _____
4.5 Determine the effluent reuse method	X Irrigation X Other's, Please specify: Domestic and Industrial use
4.6 Explain the Brine disposal method	Direct discharge to the nearest wadis - Dead sea
4.7 Determine the power source.	Jerusalem District Electricity Co Ltd. (JDECO)
4.8 Treatment Efficiency (Permate : Concentrate)	60 : 40 %
5. Capital & Operational Cost	
5.1 Capital cost of the plant	\$ 40 000 (USD)
5.2 Cost per cubic meter of desalinated water including operating and maintenance	\$ 0.346 (USD)/ M³
Comments: This Plant is the latest and the most sophisticated one among other plants in the Jordan valley area	

Name: Marj Na'jeh Desalinating Pilot plant for Agricultural use

1. General	
1.1 Location of the WTP	Marj Na'jeh Village – Jericho Governorate
1.2 Donor	Arab Organization for Agricultural Development and UNDP
1.3 Implementing Agency	Minstry of Agriculture
1.4 Designer of the WTP	--
1.5 Manufacturer of the WTP	Compatable
1.6 Operator of the WTP	Local Farmer's Assosiation
1.7 Operating hours	20 Hours/day
1.8 Establishment year	2012
1.9 Capacity of WTP	24 M ³ /Hr (treated water)
1.10 Treatment technology	Pre-filtration(Multimedia filtration – Catridge filters) – R.O
2. Status of Effluent	
1.9 Infflunet source	Agricultural ground water well
2.1 Infflunet Quality	TDS: 5000 PPM Na: 181 PPM Cl: 1914 PPM HCO₃: 274 PPM SO₄: 598 PPM
3. Specify the units included in WTP :	
Equilizing tank	x Found Not found Capacity
Intake pump	x Found Not found Q: 32 M ³ / Hr H: 20 m
R.O unit	x Found Not found Q32 M ³ / Hr H: 194 m
Disifiction unit	x Found Not found
Brine disposal method	x Found Not found Discharged to neighbouring wadi - Jordan river
PH adjustment method	Found x Not found PH: 7 -7.5
Unti-scalent unit	x Found Not found 100 lieter tank + Dosing pump
PV plant (Power Supply)	Found x Not found
Others	x Found Not found
CIP unit (Clean in Place)	Washout of Pumps and Membranes
1.3 List any chemical and their quantity used for wastewater treatment	

4. Status of Effluent	
4.1 Are there analyses for the Permate	Yes <input type="checkbox"/> x No
4.2 Permate analysis (Main parameter's)	TDS: 350 - 450 PPM Na: Cl: HC03:
4.3 Permate - Concentrate percentage	73 - 27 %
4.4 Are the results of the analysis comply with the palestininan standards.	Agricultural use <input checked="" type="checkbox"/> Yes <input type="checkbox"/> No Domestic use <input type="checkbox"/> Yes <input checked="" type="checkbox"/> No
4.5 What is the proceedure of disinfiction.	Sodium Hypochloride <input type="checkbox"/> UV Other's : <input checked="" type="checkbox"/> No Disinfiction
4.6 Determine the effluent reuse method	<input checked="" type="checkbox"/> Irrigation Total area of irrigated land : 300 Donum Other's, Please specify: _NILL
4.7 Detemine the power source.	Israeli Electricity Company 22 KW/Hr 0.4 Kw / cubic meter of desalinated water
4.8 Explane the Brine disposal method	The treatment method for the brine is discharging to the Jordan river
5. Capital and Operational Cost	
5.1 Capital cost of the plant	U\$ 160 000
5.2 Cost per cubic meter including operating and maintenance	U\$ 0.346
Comments:	

Name: PARC desalinating plant for brackish water

1. General	
1.1 Location of the WTP	Jericho
1.2 Donor	GENERALITT VALENCIANA & FPSC
1.3 Implementing Agency	PARC
1.4 Designer of the WTP	Global Environmental Services (GEC)
1.5 Manufacturer of the WTP	Different Manufacturer's
1.6 Operator of the WTP	PARC
1.7 Operating hours	Out of service
1.8 Establishment year	2011
1.9 Capacity of the desalination plant	32 M ³ /Hr
1.10 Treatment technology	Sand filtration- Catridge filters – R.O
2. Status of Effluent	
1.9 Infflunet source	Ground water well
2.1 Infflunet Quality	TDS: 3000 - 5000 PPM Na: Cl: HCO3:
3. Specify the units included in WTP :	
Equilizing tank	x Found Not found Prefabricated tank 500 M ³
Intake pump	x Found Not found Q: 32 M ³ / Hr H: 20 m
R.O unit	x Found Not found Q: 32 M ³ / Hr H: 194 m
Disifiction unit	x Found Not found Sodium Hypochloride
Brine disposal method	Found x Not found
PH adjustment method	Found x Not found
Unti-scalent unit	x Found Not found
PV plant (Power Supply)	Found x Not found
Others	Found x Not found
1.3 List any chemical and their use	Unti-scalent
4. Status of Effluent	
4.1 Are there analyses for the Permate	x Yes No
4.2 Permate analysis (Main parameter's)	TDS: 350 - 450 PPM Na: Cl: HCO3:

4.3 Are the results of the analysis comply with the palestinian standards.	Agricultural use Yes No Domestic use x Yes No
4.4 What is the procedure of disinfection.	x Sodium Hypochloride UV Other's : _____
5. Status of Solid Waste	
5.1 Determine the effluent reuse method	x Irrigation total area of irrigated land : Other's, Please specify: _____
5.2 Determine the power source.	Electricity Grid Network (JDECO)
5.3 Explain the Brine disposal method	Drying pool
5.4 Capital cost of the plant	\$ 160 000 (USD)
5.5 Cost per cubic meter including operating and maintenance	\$ 0.346 (USD)
Comments:	

Name: Zbeidat Desalinating Pilot plant for Brackish water

1. General	
1.1 Location of the WTP	Zbeidat Village
1.2 Donor	MEDRC
1.3 Implementing Agency	PWA via Al-Najah University
1.4 Designer of the WTP	Global Environmental Services (GEC)
1.5 Manufacturer of the WTP	Different Manufacturer's
1.6 Operator of the WTP	Zbeidat Local Council
1.7 Operating hours	4-6 Hours/Day
1.8 Establishment year	2012
1.9 Capacity of WTP	1.3 M ³ /Hr (5.2 – 7.8 M ³ /Day)
1.10 Treatment technology	Pre-filtration- Multimedia filtration – R.O
2. Status of Effluent	
1.9 Infflunet source	Ground water well – Main water tank
2.1 Infflunet Quality	TDS: 2636 mg/l Na: 483 mg/l Cl: 1200 mg/l HCO₃: 305 mg/l
3. Specify the units included in WTP :	
Equilizing tank	Found x Not found Supplied directly from village tank
Intake pump	x Found Not found Q: 3 M ³ / Hr H: 42.7 – 59.2 m
R.O unit	x Found Not found Q: 3 M ³ / Hr H: 192 m
Disifiction unit	Not found x Not found
Brine disposal method	Found x Not found
PH adjustment method	Found x Not found PH: 7-7.5
Unti-scalent unit	x Found Not found 100 lieter tank + Dosing pump
PV plant (Power Supply)	x Found Not found 28 Solar Module (each of 180 w)
Others CIP unit (Clean in Place)	x Found Not found Washout of Pumps and Membranes
1.3 List any other chemical and their use	Unti-scalents
4. Status of Effluent	
4.1 Are there analyses for the Permte <u>If not</u> Make your own	x Yes No
4.2 Permte analysis (Main parameter's)	TDS: 29 mg/l Na: 6.4 mg/l

(annex 3)

Checklist for Wastewater Treatment Plant's in Jericho Area

Name: Intercontenantal WWTP

1. General	
1.1 Location of the WWTP	Intercontinental Hotel – Southern Jericho
1.2 Operator of the WWTP	Intercontinentalsl Hotel – Maintenance Dept.
1.3 Establishment year	1998
1.4 What is the capacity of WWTP	800 M ³ /Day
1.5 What is the treatment technology	Bio reactors (Aeration tanks)
2. Status of Influent	
2.1 Infflunet source	Cazino, Hotel, Nearby houses
2.2 Inffluent analysis (Main parameter's)	BOD5: COD: TSS: N: P: PH:
3. Treatment Processes	
3.1 Describe Treatment Phases and the different units in the plan	Primary – Secondary – Post treatment Degreasing – Screening – Primary Sedimentation – Bioreactors – Final Sedimentation – Disinfection – Sand filtration
Pumping station	Found x Not found The wastewater flows by gravity to the WWTP
Degreasing unit	x Found Not found
Equalization tank (Sedimentation Tank)	x Found Not found
Aeration tank (ditch or channel)	x Found Not found
Final sedimentation tank	x Found Not found
Sludge thickening tank	x Found Not found
Sludge drying	x Found Not found
Disinfection unit	x Found Not found Disinfection by Sodium Hypochloride
Sand Filtration unit	x Found Not found
4. Status of Effluent	
4.1 Are there analyses for the effluent	x Yes No



4.2 effluent analysis (Main parameter's)	BOD5: COD: TDS: PH: N:
4.3 Are the results of the analysis comply with the palestinian standards.	<input checked="" type="checkbox"/> Yes <input type="checkbox"/> No
4.4 What is the procedure of disinfection.	<input checked="" type="checkbox"/> Sodium Hypochloride <input type="checkbox"/> UV <input type="checkbox"/> Other's
5. Status of Solid Waste	
5.1 Determine the effluent reuse method	<input checked="" type="checkbox"/> Irrigation Total area of irrigated land 5 ha : <input type="checkbox"/> Other's, Please explain: _____
5.2 Determine the sludge disposal method	Fertilizer or <input type="checkbox"/> Dumping at Jericho landfill
5.3 Total capital cost of the plant	<input checked="" type="checkbox"/> \$ 1,600,000 (USD)
5.4 Cost per cubic meter including O&M	<input checked="" type="checkbox"/> \$ 0.45 (USD)/m³
If a third party is involved in disposal, get documents for proof	<input type="checkbox"/> Found <input checked="" type="checkbox"/> Not found
Comments:	

Name: Modular units at Jericho hospital, Police academy, Residential Guard and Jericho Central Jail

1. General	
1.1 Location of the WWTP	Jericho Hospital – Southern Jericho
1.2 Operator of the WWTP	Jericho Hospital – Maintenance Dept.
1.3 Establishment year	2011
1.4 What is the capacity of WWTP	150 M ³ /Day
1.5 What is the treatment technology	Extended Aeration
2. Status of Influent	
2.1 Infflunet source	Jericho Hospital
2.2 Inffluent analysis (Main parameter's)	BOD5: 500 mg/l TSS: 553 mg/l N: 120 mg/l P: 13 mg/l PH: 6-9 COD: -----
3. Treatment Processes	
3.1 Describe Treatment Phases and the different units in the plan	Primary – Secondary – Post treatment Equilizing tank – Manual coarse screen – Gravity filter – Packaged unit (Aeration tank with Blowers , Diffusers and Biomedia) , Settling Tank , Chloration tank (Disinfection – Tertiary filtration (Sand filtration)
Pumping station	Found x Not found Feed pump, Effluent pumps
Degreasing unit	Found x Not found
Equalization tank (Sedimentation Tank)	x Found Not found
Aeration tank (ditch or channel)	x Found Not found
Final sedimentation tank	x Found Not found
Sludge thickening tank	x Found Not found
Sludge drying	Found x Not found
Disinfection unit	x Found Not found Disinfection by Sodium Hypochloride

Sand Filtration unit	x Found	Not found
4. Status of Effluent		
4.1 Are there analyses for the effluent <u>If not</u> Make your own	x Yes	No
4.2 effluent analysis (Main parameter's)	BOD5: 20 mg/l TSS: 20 mg/l N: 20 mg/l PH: 6 - 9 COD:	
4.3 Are the results of the analysis comply with the palestininan standards.	x Yes	No
4.4 What is the proceedure of disinfiction.	x Sodium Hypochloride	UV Other's
5. Status of Solid Waste		
5.1 Determine the effluent reuse method	x Irrigation Total area of irrigated land 0.5 ha : Other's, Please explain: Discharge surplus effluent to the nearest Wadi	
5.2 Determine the sludge disposal method	Fertilizer or dumping at Jericho landfill	
5.3 Total capital cost of the plant	\$ 120,000 (USD)	
5.4 Cost per cubic meter inculding O&M		
At full capacity (150 CMD)	\$ 0.22 (USD)/m³	
Actual operation (40 CMD)	\$ 0.81(USD)/m³	
If a third party is involved in disposal, get documents for proof	Found	x Not found
Comments:		

Appendix 4

	<p>Institute of Environmental and Water Studies <i>Collaborative Center of UNESCO-IHE Institute for Water Education</i> P. O. Box 14, BirZeit / West Bank / Palestine Tel/Fax: +970-(2)-2982120</p>	
---	--	---

إشراف: د. راشد الساعد

الرسالة

العنوان:

جدوى تحلية المياه متوسطة الملوحة والمياه المعالجة من مياه الصرف الصحي واستخدامها في الزراعة

عزيزي المشارك/ة

نرجو من حضرتك / ي التكرم بمساعدتنا في الإجابة على أسئلة هذه الاستمارة العلمية حول موضوع (جدوى تحلية المياه متوسطة الملوحة والمياه المعالجة من مياه الصرف الصحي واستخدامها في الزراعة في منطقة أريحا والاعوار) علماً بأن هذه الاستمارة هي للأغراض العلمية فقط شاكرين لكم حسن تعاونكم.

Appendix 4

Name :-----

		/ Description Question	Answers				
V1	<input type="checkbox"/>	Sex	Male (1	Female (2			
V2	<input type="checkbox"/>	Age	1) 18 – 30	2) 31 – 40	3) 41 – 50	4) Above 51	5)
V3	<input type="checkbox"/>	Education	1) Basic	2) Primary	3) Secondary	4) Bachelor Degree	5) Master degree
V4	<input type="checkbox"/>	Career ----- :	Farmer (1	Well owner (2	(3) Governmental Association	NGO's (4	Else(5
V5	<input type="checkbox"/>	Residence	1) Jericho city	2) Jericho Governorate			
V6	<input type="checkbox"/>	Water supply source	1) Ein-sultan Spring	2) Dyouk spring	3) Auja spring	4) Agricultural well	5) Another source
V7	<input type="checkbox"/>	Total annual cost for agricultural water (NIS)	1) <5000	2) 5000 - 10000	3) 10000 - 20000	4) 20000 - 30000	5) above 30000
V8	<input type="checkbox"/>	Average Annual Consumption of Agricultural water (M³)?	1) 100000– 20000	2) 21000 – 40000	3) 41000 – 60000	4) 61000 – 80000	5) above 80000
V9	<input type="checkbox"/>	How do you see the cost of one cubic meter ¢...	1) Low	2) Suitable	3) High	4) Very High	5) I have no Idea
V10	<input type="checkbox"/>	In your opinion “What is the suitable price for Agricultural water in NIS” ¢...	1) 0.2 – 0.4	2) 0.4 – 0.6	3) 0.6 – 0.8	4) 0.8 – 1	5) 1 – 1.2
V11	<input type="checkbox"/>	How do you see your knowledge in Desalination and Effluent reuse	1) Excellent	2) Very good	3) Good	4) Weak	5) I don't Know
V12	<input type="checkbox"/>	What percentage from your income you think acceptable to be deducted for Agricultural water?	1) Less than 10 %	2) 10 – 20%	3) 20 – 30%	4) 30 – 40%	5) more than 50%
V13	<input type="checkbox"/>	What is the current percentage from your income you deduct for Agricultural water	1) Less than 10%	2) 10 – 20%	3) 20 – 30%	4) 30 – 40%	5) 40 – 50%
V14	<input type="checkbox"/>	Total area of cultivated land	1) less than 2 ha	2) 2 – 4 ha	3) 4- 6 ha	4) 6-8 ha	5) above 8 ha

Appendix 4

V15	<input type="checkbox"/>	Are you satisfied with the water quantity you get for Agricultural use?				
		1) Yes	2) Sometimes	3) No	(4	(5
V16	<input type="checkbox"/>	How does water cost affect the production?				
		1) High	2) Acceptable	3) Low	4) I have no idea	(5
V17	<input type="checkbox"/>	If you are taking water from agricultural well “How much the salinity of the well “?				
		1) Low less than1000 ppm	2) Medium (2000 –1000)	3) High (3000 – 2000)	4) Very High Above 3000 ppm	(5
V18	<input type="checkbox"/>	Do you accept using the treated Effluent as an alternative source to bridge the shortage in fresh Agricultural water?				
		1) Extremely Yes	2) Yes	3) No	4)Extremely No.	5) I have no idea
V19	<input type="checkbox"/>	If you your answer for the previous question was (NO) , this is because :				
		1) Not clean	2) Health concern	3) cultural aspects	4) Psychological aspects	5)Marketing Concern
V20	<input type="checkbox"/>	Do you accept using Desalinated water as an alternative source to bridge the shortage in fresh Agricultural water?				
		1) Extremely Yes	2) Yes	3) No	4) Extremely No.	5) I have no Idea
V21	<input type="checkbox"/>	Do you accept using Blended water (Brackishwater +Treated Effluent) as an alternative source to bridge the shortage in fresh Agricultural water?				
		1) Extremely Yes	2) Yes	3) No	4) Extremely No.	5) I have no Idea
V22	<input type="checkbox"/>	If your answer for one or more of the last three questions this is because?				
		1) More Economical	2) Water conservation	3) Shortage of Fresh water	4)All mentioned	5)
V23	<input type="checkbox"/>	Do you think that using Desalinated water or Treated effluent will affect the quantity or quality of crops yield (production)				
		1) Extremely Yes	2) Yes	3) No	4) Extremely No.	5) I have no Idea
V24	<input type="checkbox"/>	Do you that think that using desalinating water and treated Effluent is enough to bridge the shortage in agricultural water?				
		1) Extremely Yes	2) Yes	3) No	4) Extremely No.	5) I have no Idea
V25	<input type="checkbox"/>	What are main Crops you cultivate in your Land?				
		1) Vegetables	2) Citrus	3) Palm trees	4) Animal Fodder	5) Other:-----
V26	<input type="checkbox"/>	If you were given enough water what is the potential land available for increase?				
		1) Less than 2 ha	2) 2 – 4 ha	3) 4- 6 ha	4) 6 -8 ha	5) more than 8 ha
V27	<input type="checkbox"/>	What Irrigation method you apply in your farm?				
		1) Drip irrigation	2) Sprinklers	3) Flood	4)all	5) another method
8V2	<input type="checkbox"/>	From your point of view “ what do you think the main problems for agriculture in the Jordan valley				

Appendix 4

			1) water shortage	2) marketing	3) High cost	4) lack of supervision and	5)All mentioned
V29	<input type="checkbox"/>	Have you ever experienced the following problems?					
			1) High Turbidity	2) Scaling in pipes, valves and sprinklers	3) Suspended solids or Particles in the water	4) all mentioned	5) Other: ----- -
V30	<input type="checkbox"/>	From your point of view, what will be the side effects for Brackish Water Desalination Projects in the Jordan Valley?					
		1) Wasting a lot of water as Brine	2)Increasing the salinity of the soil	3) High cost	4)Energy Consumption and Green Gases	5)All mentioned	

مع خالص الشكر

Questionnaire Analysis (annex 5)

Table 1: Gender, Age, Education and Career distribution of respondents

Gender					
		Frequency	Percent	Valid Percent	Cumulative Percent
Valid	Male	48	96.0	96.0	96.0
	Female	2	4.0	4.0	100.0
	Total	50	100.0	100.0	
Age / Year					
Valid	18 – 30	5	10.0	10.0	10.0
	31 – 40	8	16.0	16.0	26.0
	41 – 50	14	28.0	28.0	54.0
	Above 51	23	46.0	46.0	100.0
	Total	50	100.0	100.0	
Education					
Valid	Basic	16	32.0	32.0	32.0
	Primary	14	28.0	28.0	60.0
	Secondary	15	30.0	30.0	90.0
	Bachelor Degree	4	8.0	8.0	98.0
	Master degree	1	2.0	2.0	100.0
	Total	50	100.0	100.0	
Career					
Valid	Farmer	41	82.0	82.0	82.0
	Well owner	2	4.0	4.0	86.0
	Governmental Association	2	4.0	4.0	90.0

Gender					
		Frequency	Percent	Valid Percent	Cumulative Percent
Valid	Male	48	96.0	96.0	96.0
	Female	2	4.0	4.0	100.0
	NGO's	3	6.0	6.0	96.0
	Else	2	4.0	4.0	100.0
	Total	50	100.0	100.0	

Table 2: Water supply in study area

Water Supply					
		Frequency	Percent	Valid Percent	Cumulative Percent
Valid	Ein-sultan Spring	6	12.0	12.0	12.0
	Dyook spring	2	4.0	4.0	16.0
	Auja spring	3	6.0	6.0	22.0
	Agricultural well	38	76.0	76.0	98.0
	Other source	1	2.0	2.0	100.0
	Total	50	100.0	100.0	
Satisfaction on Water Supply					
Valid	Yes	10	20.0	20.0	20.0
	Sometimes	32	64.0	64.0	84.0
	No	8	16.0	16.0	100.0
	Total	50	100.0	100.0	
Average Annual Consumption of Agricultural Water					
Valid	100000–20000	5	10.0	10.0	10.0
	21000 –40000	24	48.0	48.0	58.0

	41000 –60000	7	14.0	14.0	72.0
	61000 –80000	4	8.0	8.0	80.0
	above 80000	10	20.0	20.0	100.0
	Total	50	100.0	100.0	

Table 3: Agricultural Water Cost and Land Availability

Average Annual Cost for Agricultural Water in NIS					
		Frequency	Percent	Valid Percent	Cumulative Percent
Valid	< 5000	5	10.0	10.0	10.0
	5000 - 10000	19	38.0	38.0	48.0
	10000 - 20000	16	32.0	32.0	80.0
	Above 30000	10	20.0	20.0	100.0
	Total	50	100.0	100.0	
The current percentage from total income deducted for Agricultural water					
Valid	Less than 10 %	17	34.0	34.0	34.0
	10 – 20%	27	54.0	54.0	88.0
	20 – 30%	4	8.0	8.0	96.0
	40 – 50%	2	4.0	4.0	100.0
	Total	50	100.0	100.0	
Total area of lands available for cultivation					
Valid	less than 2 ha	13	26.0	26.0	26.0
	2 – 4 ha	17	34.0	34.0	60.0
	4- 6 ha	7	14.0	14.0	74.0
	6-8 ha	2	4.0	4.0	78.0
	above 8 ha	11	22.0	22.0	100.0
	Total	50	100.0	100.0	

Land Availability for Future Development					
Valid	Less than 2 ha	12	24.0	24.0	24.0
	2 – 4 ha	20	40.0	40.0	64.0
	4- 6 ha	13	26.0	26.0	90.0
	6 -8 ha	1	2.0	2.0	92.0
	more than 8 ha	4	8.0	8.0	100.0
	Total	50	100.0	100.0	

Table 4: Satisfaction to Water supply, Cost and Land availability

Satisfactory Percentage from total income to be deducted for Agricultural Water					
		Frequency	Percent	Valid Percent	Cumulative Percent
Valid	Less than 10 %	31	62.0	62.0	62.0
	10 – 20%	13	26.0	26.0	88.0
	20 – 30%	3	6.0	6.0	94.0
	30 – 40%	1	2.0	2.0	96.0
	more than 50%	2	4.0	4.0	100.0
	Total	50	100.0	100.0	
Acceptable price for one cubic meter of Agricultural Water.					
Valid	Low	9	18.0	18.0	18.0
	Suitable	15	30.0	30.0	48.0
	High	21	42.0	42.0	90.0
	Very High	5	10.0	10.0	100.0
	Total	50	100.0	100.0	
Suitable price for Agricultural water in NIS from consumers point of view					
Valid	0.2 – 0.4	34	68.0	68.0	68.0

Satisfactory Percentage from total income to be deducted for Agricultural Water					
		Frequency	Percent	Valid Percent	Cumulative Percent
Valid	Less than 10 %	31	62.0	62.0	62.0
	10 – 20%	13	26.0	26.0	88.0
	20 – 30%	3	6.0	6.0	94.0
	30 – 40%	1	2.0	2.0	96.0
	more than 50%	2	4.0	4.0	100.0
	Total	50	100.0	100.0	
	0.4 – 0.6	15	30.0	30.0	98.0
	0.6 – 0.8	1	2.0	2.0	100.0
	Total	50	100.0	100.0	
Effect of Water Cost on the production					
Valid	High	28	56.0	56.0	56.0
	Acceptable	18	36.0	36.0	92.0
	Low	4	8.0	8.0	100.0
	Total	50	100.0	100.0	

Table 5: Water Quality

Salinity of Water Source					
		Frequency	Percent	Valid Percent	Cumulative Percent
Valid	Low less than1000 ppm	7	14.0	14.0	14.0
	Medium (1000– 2000)	14	28.0	28.0	42.0
	High (2000 – 3000)	14	28.0	28.0	70.0

	Very High Above 3000 ppm	15	30.0	30.0	100.0
	Total	50	100.0	100.0	
Have you ever experienced the following problems?					
	Frequency	Percent	Valid Percent	Cumulative Percent	
Valid	High Turbidity	4	8.0	8.0	8.0
	Scaling in pipes, valves and sprinklers	28	56.0	56.0	64.0
	Suspended solids or Particles in the water	7	14.0	14.0	78.0
	all mentioned	10	20.0	20.0	98.0
	Other	1	2.0	2.0	100.0
	Total	50	100.0	100.0	

Table 6: Awareness and Willingness to use of brackish Water and Treated Effluent

Awareness and Knowledge on Desalination					
		Frequency	Percent	Valid Percent	Cumulative Percent
Valid	Very good	6	12.0	12.0	12.0
	Good	16	32.0	32.0	44.0
	Weak	22	44.0	44.0	88.0
	I don't Know	6	12.0	12.0	100.0
	Total	50	100.0	100.0	
Acceptance of treated effluent as an alternativewater source to bridge the shortage in fresh agricultural water?					
Valid	Extremely Yes	3	6.0	6.0	6.0
	Yes	10	20.0	20.0	26.0
	No	24	48.0	48.0	74.0

Awareness and Knowledge on Desalination					
		Frequency	Percent	Valid Percent	Cumulative Percent
Valid	Very good	6	12.0	12.0	12.0
	Good	16	32.0	32.0	44.0
	Weak	22	44.0	44.0	88.0
	I don't Know	6	12.0	12.0	100.0
	Total	50	100.0	100.0	
	Extremely No	12	24.0	24.0	98.0
	I have no idea	1	2.0	2.0	100.0
	Total	50	100.0	100.0	
Reasons behind the rejection of treated effluent					
Valid	Not clean	10.0	28.0	28.0	28.0
	Health concern	15.0	40.0	40.0	68.0
	cultural aspects	5.0	14.0	14.0	82.0
	Psychological aspects	4.0	10.0	10.0	92.0
	Marketing Concern	3.0	8.0	8.0	100.0
	Total	37	100.0	100.0	
Acceptance of Desalinated brackish water as an alternative water source to bridge the shortage in fresh agricultural water.					
Valid	Extremely Yes	16	32.0	32.0	32.0
	Yes	31	62.0	62.0	94.0
	No	3	6.0	6.0	100.0
	Total	50	100.0	100.0	
Acceptance of Blended water (brackish water +Treated Effluent) as an alternative source to bridge the shortage in fresh Agricultural water?					
Valid	Extremely Yes	5	10.0	10.0	10.0

Awareness and Knowledge on Desalination					
		Frequency	Percent	Valid Percent	Cumulative Percent
Valid	Very good	6	12.0	12.0	12.0
	Good	16	32.0	32.0	44.0
	Weak	22	44.0	44.0	88.0
	I don't Know	6	12.0	12.0	100.0
	Total	50	100.0	100.0	
	Yes	24	48.0	48.0	58.0
	No	21	42.0	42.0	100.0
	Total	50	100.0	100.0	

Reasons Behind the Acceptance of Desalinated Water and Blended water?					
Valid	More Economical	15	30.0	30.0	30.0
	Water conservation	7	14.0	14.0	44.0
	Shortage of Fresh water	8	16.0	16.0	60.0
	All mentioned	20	40.0	40.0	100.0
	Total	50	100.0	100.0	

Is Desalinated and Effluent Treatment enough to bridge the shortage in agricultural water?					
Valid	Extremely Yes	6	12.0	12.0	12.0
	Yes	30	60.0	60.0	72.0
	No	14	28.0	28.0	100.0
	Total	50	100.0	100.0	

Table 7: Farm Management results

Awareness and Knowledge on Desalination					
		Frequency	Percent	Valid Percent	Cumulative Percent
Valid	Vegetables	33	66.0	66.0	66.0
	Citrus	9	18.0	18.0	84.0
	Palm trees	2	4.0	4.0	88.0
	Animal Fodder	2	4.0	4.0	92.0
	Other	4	8.0	8.0	100.0
	Total	50	100.0	100.0	
Irrigation method					
Valid	Drip irrigation	50	100.0	100.0	100.0
The Main Problemsfor the agriculture in the Jordan valley.					
Valid	water shortage	15	30.0	30.0	30.0
	marketing	17	34.0	34.0	64.0
	High cost	3	6.0	6.0	70.0
	lack of supervision	1	2.0	2.0	72.0
	All mentioned	14	28.0	28.0	100.0
	Total	50	100.0	100.0	
Expected Side effects for the Desalination Technology					
Valid	Wasting a lot of water as Brine	6	12.0	12.0	12.0
	Increasing the salinity of the soil	11	22.0	22.0	34.0
	High cost	19	38.0	38.0	72.0
	All mentioned	14	28.0	28.0	100.0
	Total	50	100.0	100.0	

Table 1: Arab Development Society wells (annex 6)

NO.	WELL ID	Depth	STATUS	Current Abstraction CM/H	Licensed AbstractionCM/Y	NOTES
1	19-14-64 Bawaba Well	90	Out of service	0	50,000	The permit was used to drill a new well
2	19-14-67 Hawooz Well	100	In duty	243,000 ¹	50,000	New well has been drilled Pump: 40 HP 6 inch water pipe Salinity : Medium
3	19-14-66 Offices well	130	In Duty	243,000 ¹	50,000	New well has been drilled Pump: 30 HP 3 inch water pipe Capacity 45 CMH Depth 130 m Salinity : Medium

¹ Abstraction calculated based on 18 pumping hours *300 working day's * 45 CM/H = 243,000 CM/Y

4	19-14-73 Zaiton Well Old ID 19-14-72	100	Replaced by new well	108,000 ²	50,000	Pump: 30 HP 4 inch water pipe Salinity : Low Require cleaning
5	19-14-70 Zefteh well	250	Require Rehabilitation or Drilling of New well	37800 ³	50,000	Pump: 15 HP 4 inch water pipe Salinity : High Salinity Require cleaning
6	19-14-65	110	Out of service	0	50,000	Require drilling of new well
7	19-14-69	132	Out of service	0	0	Require drilling of new well
8	19-14-75 Nokta Well	77	Out of service	0	50,000	Require drilling of new well
9	19-14-76	80	Out of service	0	50,000	Require drilling of new well
10	19-14-73/A	100	Out of service	0	50,000	Require drilling of new well
11	19-14-91	137	Out of service	0	50,000	Require drilling of new well
12	19-14-77	--	Out of service	0	50,000	Northern Project

²Abstraction calculated based on 18 pumping hours *300 working day's * 20 CM/H = 108,000 CM/Y

³Abstraction calculated based on 18 pumping hours *300 working day's * 7 CM/H = 37,800 CM/Y

13	19-14-78	--	Out of service	0	50,000	Northern Project
14	19-14-79	--	Out of service	0	50,000	Northern Project
15	19-14-81	100	Out of service	0	50,000	Northern Project
16	19-14-85	--	Out of service	0	50,000	Northern Project
17	19-14-84	--	Out of service	0	50,000	Northern Project
18	19-14-86	--	Out of service	0	50,000	Northern Project
19	19-14-87	--	Out of service	0	50,000	Northern Project
20	19-14-92	--	Out of service	0	50,000	Northern Project
21	19-14-98	195	Out of service	0	50,000	Northern Project
22	19-14-68	250	Out of service	0	50,000	Require drilling of new well
23	19-14-71	94	Out of service	0	50,000	Require drilling of new well
24	19-14-80	100	Out of service	0	50,000	Require drilling of new well
TOTAL (CM/H)				631,800	1,200,000	

(Annex 7)

جدول 1: Estimated Cost for constructing of small scale Earth pool for Flash flood rain water harvesting (Bsharat , 2012)

Number	Description	Context	Unit	Quantity	Price	Total amount
1	Mechanical earth continuous digging in medium consistency ground (not rock) and storage of material excavated close to excavation	Length 50m x Width 40 x Depth 4 m (1 meter above ground)	cubic meter	9500	\$ 2.00	\$ 19,000.00
2	Mechanical earth continuous digging in rocky ground and storage of material excavated close to excavation	same as above, if there is presence of rocks (assume 5% of above quantity)	cubic meter	500.00	\$ 20.00	\$ 10,000.00
3	Shaping of excavated materials (coming after excavation)to create boundary walls of 1 meter above the natural ground level, watering and compacting in order to grade the surface	The total area of the pool including 4 sides	square meter	9500.00	\$ 2.00	\$ 19,000.00
4	Laying, watering and compaction of 10 cm clay layer for reverse filter (d < 0.002 mm) for ground and pool boundary walls	covering the total area of the pool (ground + boundary walls)	cubic meter	300.00	\$ 2.00	\$ 600.00
5	Optional Item: Laying ofPlastic liner thickness not less than 0.6 mm	in order to waterproof the gabions	square meter	3000.00	\$ 5.00	\$ 15,000.00
6	Optional Item: Laying 10 cm of Wadi coarse above plastic liner	To protect from damage	cubic meter	300.00	\$ 2.00	\$ 600.00

7	Gabions 1 x 1 x 2 m with stones, from outside the wadi, and easonal mesh. The minimum size of the boulders is dictated by the gap size in the wire mesh. The boulders should be hard and should not deteriorate under water. Angular boulders are to be preferred to round boulders. Arrange smaller sized boulders in such a way that they fill the gap left by larger sized boulders. Besides rendering the structure less permeable.	Gabions will be used to build up the diversion Canal across the Wadi	cubic meter	100.00	\$ 100.00	\$ 10,000.00
8	Plantation of selected trees or other kind of "agricultural plants" on the pool boundary	to protect from erosion (fruits, or similar)	NO.	40	\$ 30.00	\$ 1,200.00
9	Installation of water level indicator galvanized steel bar with scaling in the center of the pool	to estimate the water volume inside the pool	lump sump	1	\$ 150.00	\$ 150.00
10	Supply and install galvanized steel wire mesh fence Ø2.5mm of standard 4*4cm spacing using Ø2" and Ø4" galvanized steel pipes, complete with all concrete supports and all necessary fittings and wiring as per drawings and specifications, fence height 1.5 meter	safety Fence	M.R	200	\$ 12.00	\$ 2,400.00
11	Supply and Fix Main Entrance Steel Gates. Sashes are framed by (80*40*2) mm Steel Tube for edges & partitions. Covered with 2 mm thick steel sheeting for the lower part. Protection grill of the upper part shall be of Sec. (14*14 mm) solid steel. Price to include cylindrical locks, ironmonger, hinges, three coats of oil paint on two coats of primer coat, and all related works as per drawings, specifications and supervisor engineer.	Entrance	lump sump	1	\$ 800.00	€ 800.00
TOTAL						\$ 78,750.00